

REMEEDER HOUSE

580 SUTTER AVE

COGENERATION SYSTEM

(BLOCK 3769, LOT 1)

DRAWING INDEX:

SHEET NO.	TITLE OF DRAWING
T-101.00	TITLE SHEET, GENERAL NOTES & MECHANICAL SYMBOL LIST
G-101.00	ENERGY ANALYSIS
M-101.00	MECHANICAL/HVAC SCHEDULES & FLOW DIAGRAM
M-201.00	CELLAR MECHANICAL PLAN
M-301.00	MECHANICAL/HVAC DETAILS
P-101.00	PLUMBING/GAS PIPING PLAN
P-201.00	PLUMBING DETAIL & GAS RISER DIAGRAM
E-101.00	ELECTRICAL CELLAR PLAN
E-102.00	ELECTRICAL CELLAR PLAN
E-201.00	ELECTRICAL DETAILS

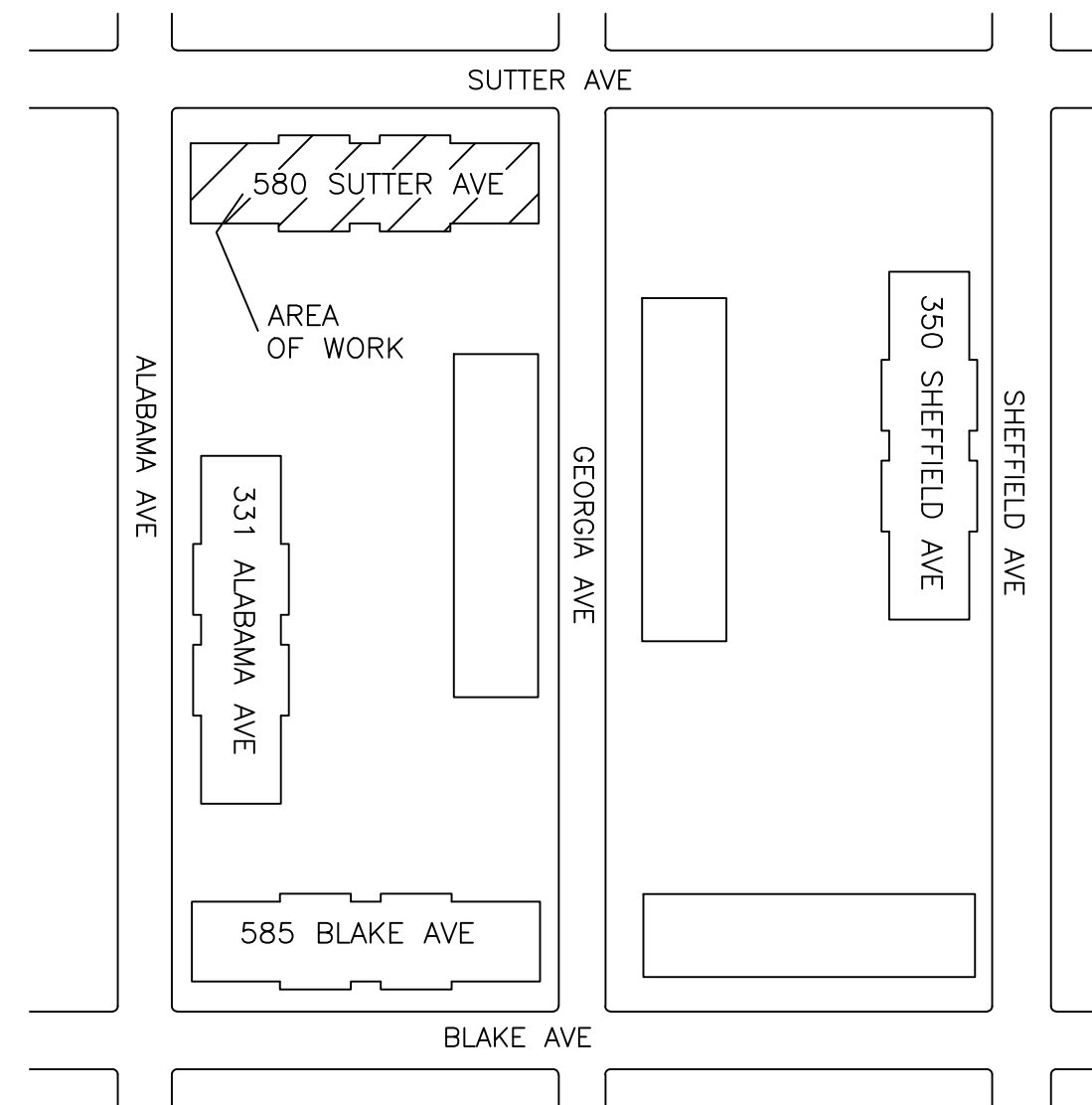

GENERAL NOTES:

- CONTRACTOR TO VERIFY ALL DIMENSIONS IN FIELD PRIOR TO CONSTRUCTION, AND REPORT TO ENGINEER ALL ERRORS, DISCREPANCIES, OMISSIONS, DEFECTS, OR UNUSUAL WORK CONDITIONS BEFORE COMMENCING CONSTRUCTION.
- ALL WORK IS TO BE PERFORMED IN ACCORDANCE WITH THE APPLICABLE RULES AND REGULATIONS OF ALL GOVERNING AGENCIES INCLUDING BUT NOT LIMITED TO THE CODES AND REGULATIONS AS SET FORTH BY THE CITY OF NEW YORK AND STATE OF NEW YORK.
- CONTRACTOR TO SECURE ALL NECESSARY PERMITS REQUIRED FOR THE STIPULATED WORK PRIOR TO COMMENCING WITH CONSTRUCTION OR DEMOLITION.
- ALL ASBESTOS REMOVAL, PLUMBING, ELECTRICAL, WELDING WORK, ETC. TO BE PERFORMED BY LICENSED CONTRACTORS SUBCONTRACTED BY AEGIS ENERGY SERVICES.
- ALL CONTRACTORS, WORKMEN, AND AGENTS WORKING AT OR VISITING THE SITE SHALL BE COVERED BY ALL NECESSARY STATUTORY INSURANCE INCLUDING LIABILITY, WORKMEN'S COMPENSATION, DISABILITY, ETC.
- ALL WORK SHALL BE PERFORMED IN A NEAT, CLEAN, ORDERLY MANNER AND THE SITE KEPT CLEAN FROM DUST AND DEBRIS AT ALL TIMES.
- CONTRACTORS TO PROVIDE ALL NECESSARY TEMPORARY LIGHTING, POWER, WATER, WATERPROOFING, ETC. NEEDED TO ENSURE PROJECT SAFETY AT ALL TIMES.
- CONTRACTORS TO PROVIDE ALL NECESSARY SHORING, BRIDGING, BARRICADES, SIGNS, ETC. NEEDED TO ENSURE PROJECT SAFETY AT ALL TIMES.
- ALL WORK, INCLUDING TESTING AND TEMPORARY SHUT DOWN OF SERVICES IS TO BE COORDINATED WITH OWNER'S SCHEDULE FOR DELIVERIES, WORKDAYS, TIMES, ETC.
- ALL NEW WORK TO BE THOROUGHLY TIED AND BONDED TO EXISTING WORK
- ALL PATCHING AND JOINING SHALL BE NEAT, CLEAN, AND SQUARE, MATCHING ADJACENT SURFACES IN FINISH AND TEXTURE.
- ALL FIRE RETARDANT MATERIALS SHALL BEAR STAMPS, SEALS, AND/OR PERMANENT LABELS AS REQUIRED. AFFIDAVITS SHALL BE PROVIDED WHEN REQUESTED.
- ALL WORK TO BE PLUMB, LEVEL, AND TO THE BEST OF WORKMANSHIP
- CONTRACTOR TO FULLY COORDINATE HIS WORK AND EFFORTS WITH OTHER TRADES TO ENSURE A NEAT, PROPER, DIMENSIONALLY ACCURATE JOB IN ALL RESPECTS TO RELATED WORK.
- THE JOB SHALL BE ADEQUATELY STAFFED AT ALL TIMES TO ENSURE CONTINUITY AND PROGRESS, WITH ALL PHASES/SEGMENTS OF WORK PROPERLY COORDINATED.
- ALL DEFECTIVE OR UNACCEPTABLE WORK SHALL BE REMOVED AND REPLACED, INCLUDING ANY SURROUNDING AFFECTED AREAS, AT NO ADDITIONAL COST TO THE OWNER.
- CONTRACTOR TO SUBMIT SHOP DRAWINGS AND SAMPLES FOR ENGINEER'S APPROVAL WHERE REQUIRED BY DOCUMENTS PRIOR TO PROCEEDING WITH WORK
- ALL WORK, UNLESS OTHERWISE SPECIFIED, TO BE GUARANTEED FOR A MINIMUM OF ONE YEAR FROM FINAL ACCEPTANCE.
- ANY MATERIAL COMPOSITION WHICH IS QUESTIONABLE SHALL BE BROUGHT TO THE ATTENTION OF THE ENGINEER. THE DETERMINATION OF THE ACCEPTABILITY OF ALL MATERIALS SHALL BE AT THE SOLE DISCRETION OF THE ENGINEER.
- ANY CONFLICT BETWEEN THE SPECIFICATIONS AND DRAWINGS IS TO BE BROUGHT TO THE ATTENTION OF THE ENGINEER PRIOR TO WORK.
- ALL PIPES TO BE INSULATED WITH 1" HEAVY DENSITY FIBERGLASS INSULATION WITH ALL SURFACE JACKET.
- ALL PIPING TO BE HARD COPPER "L" GRADE UNLESS OTHERWISE SPECIFIED.

TENANT PROTECTION PLAN:

- THE BUILDING CONTAINS SPACES WHICH WILL BE OCCUPIED DURING CONSTRUCTION.
- EGRESS: DURING THE COURSE OF CONSTRUCTION EGRESS FROM ALL FLOORS SHALL BE MAINTAINED AT ALL TIMES.
- FIRE SAFETY: ALL REQUIRED PRECAUTIONS WILL BE TAKEN TO PROVIDE FIRE SAFETY DURING CONSTRUCTION.
- HEALTH REQUIREMENTS: DUST SHALL BE KEPT AT A MINIMUM AND SHALL BE REMOVED AT THE END OF EACH WORKING DAY. CONSTRUCTION DEBRIS SHALL BE DISPOSED IN A SAFE MANNER. CONSTRUCTION NOISE WILL BE CEASED AFTER NORMAL WORKING HOURS. NOISE SHALL BE LIMITED TO ACCEPTABLE LIMITS. SANITARY FACILITIES SHALL BE PROVIDED AT ALL TIMES. PEST CONTROL SHALL BE PROVIDED AT ALL TIMES DURING THE COURSE OF CONSTRUCTION.
- THE CONTRACTOR SHALL COMPLY WITH APPLICABLE LAWS RELATING TO LEAD AND ASBESTOS. IN CASE LEAD OR ASBESTOS ARE FOUND THE OWNER OR ENGINEER SHALL BE INFORMED IMMEDIATELY.
- ELECTRICAL, GAS OR OTHER UTILITIES SHALL NOT BE INTERRUPTED DURING CONSTRUCTION. CONTRACTOR OR OWNER SHALL NOTIFY THE TENANT IN WRITING BEFORE ANY INTERRUPTION OF SERVICES IS PERFORMED.
- BUILDING SECURITY SHALL BE MAINTAINED TO PREVENT UNAUTHORIZED PERSONS FROM ENTERING THE BUILDING.
- FLOORS SHALL NOT BE OVERLOADED BEYOND PERMISSIBLE LIMITS.
- NO STRUCTURAL WORK SHALL BE PERFORMED WHICH MAY ENDANGER THE OCCUPANTS.
- CONSTRUCTION OPERATION SHALL BE CONFINED TO NORMAL WORKING HOURS: 8:00 A.M. THROUGH 5:00 P.M. MONDAY THROUGH FRIDAY, EXCEPT LEGAL HOLIDAYS, UNLESS AUTHORIZED IN WRITING BY OWNERS.

ADDRESS: 580 SUTTER AVE
 BIN: 3342520
 BLOCK: 3769
 LOT: 1
 # BUILDINGS: 3 (ALL WORK AT 3342520)
 # FLOORS: 6 & CELLAR
 GROSS AREA: 153,588
 # DWELLING UNITS: 65
 YEAR OF CONSTRUCTION: 1975

REVIEWER NOTE:

THE SCOPE OF WORK FOR THIS PROJECT INCLUDES THE INSTALLATION OF ONE (1) 35KW MODULAR COGENERATION MODULES TO GENERATE HEAT AND ELECTRICITY FOR REMEEDER HOUSE, 580 SUTTER AVE, NEW YORK, NEW YORK, 11207

NOTE:

- DRAWINGS ARE TO BE READ, NOT SCALED.
- ALL WORK SHALL CONFORM TO THE 2014 NEW YORK CITY BUILDING CODE.
- TO THE BEST OF OUR KNOWLEDGE, BELIEF, AND PROFESSIONAL JUDGMENT, SUCH PLANS AND SPECIFICATIONS ARE IN CONFORMANCE WITH THE 2014 NYC ENERGY CONSERVATION CONSTRUCTION CODE. PIPING HAVE BEEN SPECIFIED TO BE INSULATED WITH R-3 INSULATION, DOMESTIC HOT WATER STORAGE TANKS HAVE R-13 INSULATION AND COGENERATION MODULE MEETS EFFICIENCY REQUIREMENTS. SEE ENERGY ANALYSIS ON SHEET G-1.
- ALL CONDITIONS ARE EXISTING EXCEPT AS NOTED.
- THESE PLANS ARE APPROVED ONLY FOR THE WORK INDICATED ON THE APPLICATION SPECIFICATION SHEET. ALL OTHER MATTERS SHOWN ARE NOT TO BE RELIED UPON OR TO BE CONSIDERED EITHER APPROVED OR IN ACCORDANCE WITH APPLICABLE CODE. NO CHANGE IN USE, EGRESS OR OCCUPANCY.

SPECIAL/PROGRESS INSPECTION REQUIREMENTS:

THE FOLLOWING ITEMS OF WORK SHALL BE SUBJECT TO SPECIAL AND/OR PROGRESS INSPECTION, MADE AND WITNESSED BY OR UNDER THE DIRECT SUPERVISION OF AN ARCHITECT OR ENGINEER RETAINED BY THE CONTRACTOR WHO SHALL BE QUALIFIED TO PERFORM SUCH INSPECTIONS. A TEST REPORT AND CERTIFICATE OF INSPECTION SHALL BE FILED WITH THE BUILDING DEPARTMENT.

- MECHANICAL SYSTEMS - BC 1704.16
- HEATING SYSTEMS - BC 1704.25
- FIRESTOP, DRAFTSTOP & FIREBLOCK - BC 1704.27

SPECIAL INSPECTIONS/PROGRESS (TR-1)		ENERGY CODE COMPLIANCE INSPECTIONS (TR-8)	
<input checked="" type="checkbox"/>	MECHANICAL SYSTEMS	BC 1704.16	<input checked="" type="checkbox"/> HVAC & SERVICE WATER HEATING EQUIPMENT
<input checked="" type="checkbox"/>	HEATING SYSTEMS	BC 1704.25	<input checked="" type="checkbox"/> HVAC & SERVICE WATER HEATING CONTROLS
<input checked="" type="checkbox"/>	FIRE-RESISTANT PENETRATIONS AND JOINTS	BC 1704.27	<input checked="" type="checkbox"/> DUCT PLENUM AND PIPING INSULATION & SEALING
<input checked="" type="checkbox"/>	ENERGY CODE COMPLIANCE INSPECTION	BC 110.3.5	<input checked="" type="checkbox"/> MAINTENANCE INFORMATION

MECHANICAL SYMBOLS LIST:

	METER
	CIRCULATION PUMP
	TEMPERATURE SENSOR
	BALL VALVE
	BUTTERFLY VALVE
	UNION
	THERMOMETER
	PRESSURE RELIEF VALVE
	AQUASTAT
	STRAINER - Y TYPE
	MANUAL AIR VENT
	FLOW DIRECTION
	COGEN TEMPERATURE SENSOR
	GATE VALVE
	CHECK VALVE
	FLOW CHECK
	FAN/COIL UNIT
	HEAT EXCHANGER
	3-WAY VALVE A: NORMALLY CLOSED B: NORMALLY OPEN AB: MIXED WATER
N.O.	NORMALLY OPEN/ON
N.C.	NORMALLY CLOSED/OFF
C.W.	CLOSED WINTER
C.S.	CLOSED SUMMER
	POINT OF CONNECTION TO EXISTING

	CW	COLD WATER (DOMESTIC)
	CWF	COLD WATER FILL
	HWS	BUILDING HEAT SUPPLY
	HRW	BUILDING HEAT RETURN
	DHWR	BUILDING DHW RETURN
	DHWS	BUILDING DHW CIRCULATION
	C	COGEN PROCESS LOOP PIPING
	CDHW	COGEN DHW SUPPLY
	GS	GLYCOL SUPPLY
	GR	GLYCOL RETURN
	E	COGEN EXHAUST PIPE
	G	COGEN GAS LINE

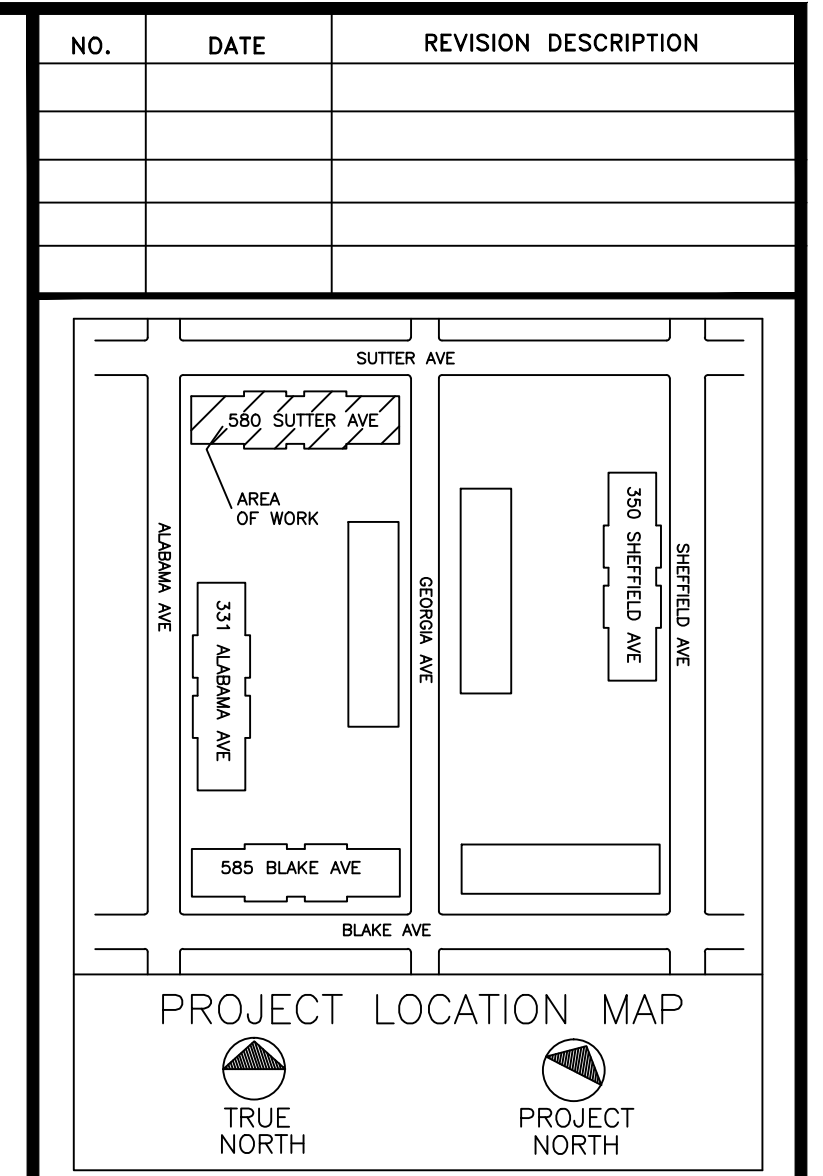

CLIENT:
 AEGIS ENERGY SERVICES, INC
 55 JACKSON STREET
 HOLYOKE, MA 01040
 TEL.: 413-536-1156
 FAX: 413-536-1104
 ATTN: KEVIN MAY

ALL DRAWINGS ARE TO
 BE READ NOT SCALED.

STATEMENT:
 IT IS A VIOLATION OF THE LAW FOR ANY PERSON, UNLESS ACTING UNDER THE DIRECTION OF A LICENSED ENGINEER/ARCHITECT, TO ALTER IN ANY WAY, ANY ITEM ON THESE DRAWINGS. IF AN ITEM BEARING THE SEAL OF AN ENGINEER/ARCHITECT IS ALTERED, THE ALTERING ENGINEER/ARCHITECT SHALL AFFIX TO THIS ITEM THEIR SEAL AND THE NOTATION "ALTERED BY", FOLLOWED BY HIS/HER SIGNATURE AND THE DATE OF SUCH ALTERATION, ALONG WITH A SPECIFIC DESCRIPTION OF THE ALTERATION ON THE DRAWING.

PROPRIETARY STATEMENT:
 THE PLANS AND SPECIFICATIONS HEREIN ARE INTENDED FOR THE SUBJECT PROJECT ONLY AND AS A RESULT OF CONTRACTUAL NEGOTIATIONS BETWEEN BECKER ENGINEERING, PC, THESE PLANS AND SPECIFICATIONS WILL BE THE SUBJECT OF A COPYRIGHT PETITION AND MAY NOT BE REVISED OR REUSED BY ANYONE WITHOUT THE WRITTEN AUTHORITY OF BECKER ENGINEERING, PC.

PREPARED BY:
 BECKER ENGINEERING, PC
 777 SUNRISE HIGHWAY, SUITE 300
 LYNBROOK, NY 11563
 PHONE: (516) 561-5922
 FAX: (516) 823-0219 EMAIL:
 SUPPORT@BEPC.US
 WEB: WWW.BEPC.US

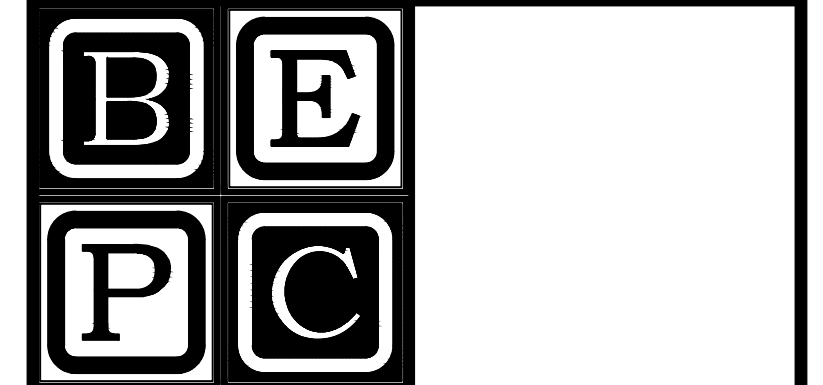

PROJECT
 REMEEDER HOUSE
 COGENERATION PROJECT
 580 SUTTER AVE
 BROOKLYN, NY 11207

DRAWING TITLE:
 TITLE SHEET, GENERAL
 NOTES & MECHANICAL
 SYMBOL LIST

DESIGN BY:	SP	DATE:	08/30/16
DRN BY:	SP	DATE:	08/30/16
CKD BY:	.	DATE:	.
FINAL CKD BY:	.	DATE:	.
SCALE:	AS NOTED	DATE:	
DWG No.	PAGE 1 OF 10		

T-101.00
 PROJECT NO.
 60-341
 B-SCAN:

	INSPECTION/TEST SCHEDULE	FREQUENCY (MINIMUM)	REFERENCE STANDARD (SEE NYCECC CHAPTER 6)	NYCECC OR OTHER CITATION
IIB3	HVAC, SERVICE WATER HEATING AND POOL EQUIPMENT SIZING AND PERFORMANCE FACTORS OF ALL MAJOR EQUIPMENT UNITS, AS DETERMINED BY THE APPLICANT OF RECORD, AND NO LESS THAN 15% OF MINOR EQUIPMENT UNITS, SHALL BE VERIFIED BY VISUAL INSPECTION AND, WHERE NECESSARY, REVIEW OF MANUFACTURE'S DATA. POOL HEATERS AND COVERS SHALL BE VERIFIED BY VISUAL INSPECTION.	PRIOR TO FINAL PLUMBING AND CONSTRUCTION INSPECTION	AFTER INSTALLATION AND PRIOR TO CLOSING SHAFTS CEILING AND WALLS	C403.1, C404.2, C404.7
IIB4	HVAC SYSTEM CONTROLS AND ECONOMIZERS AND SERVICE HOT WATER SYSTEM CONTROLS: NO LESS THAN 20% OF EACH TYPE OF REQUIRED CONTROLS AND ECONOMIZERS SHALL BE VERIFIED BY VISUAL INSPECTION AND TESTED FOR FUNCTIONALITY AND PROPER OPERATION	AFTER INSTALLATION AND PRIOR TO FINAL ELECTRICAL AND CONSTRUCTION INSPECTION, EXCEPT THAT FOR CONTROLS WITH SEASONALLY DEPENDENT FUNCTIONALITY, SUCH TESTING SHALL BE APPROVED CONSTRUCTION DOCUMENTS, INCLUDING CONTROL SYSTEM NARRATIVES; ASHRAE GUIDELINE 1: THE HVAC COMMISSIONING PROCESS WHERE APPLICABLE C403.2.4, C403.2.5.1, C403.2.11, C403.2, C403.2.2, C403.3.3, C403.3, C404.6, C404.7 PERFORMED BEFORE SIGNOFF FOR ISSURANCE OF A FINAL CERTIFICATE OF OCCUPANCY	APPROVED CONSTRUCTION DOCUMENTS INCLUDING CONTROL SYSTEM NARRATIVES ASHRAE GUIDELINE 1: THE HVAC COMMISSIONING PROCESS WHERE APPLICABLE	C403.2.4, C403.2.5.1, C403.2.11, C403.2, C403.3.3, C403.3, C404.6, C404.7
IIB5	HVAC INSULATION AND SEALING: INSTALLED DUCTS AND PIPING INSULATION SHALL BE VISUALLY INSPECTED TO VERIFY PROPER INSULATION PLACEMENT AND VALUES. JOINS, LONGITUDINAL AND TRANSVERSE SEAMS AND CONNECTIONS IN DUCTWORK SHALL BE VISUALLY INSPECTED FOR PROPER SEALING.	PERFORMED BEFORE SIGN OFF FOR ISSUANCE OF FINAL CERTIFICATE OF OCCUPANCY	APPROVED CONSTRUCTION DOCUMENTS: SMACNA DUCT CONSTRUCTION STANDARDS. METAL AND FLEXIBLE: UL 181A OR UL 181B	C403.2.7, C403.2.8, C404.5

ENERGY ANALYSIS FOR ALTERATION – 2014 NYCECC – CHAPTER C4, CLIMATE ZONE 4		
EQUIPMENT		
ITEM TAG	COGENERATION MODULE	
NYCECC CITATION	C404.3	C404.5
PROVISION	TEMPERATURE CONTROLS	PIPE INSULATION
ITEM DESCRIPTION	TEMPERATURE CONTROLS	PIPE INSULATION
PROPOSED DESIGN VALUE	MIXED WATER TEMPERATURE SET FOR 110°F	2" INSULATION SHALL BE USED ON ALL HOT WATER SERVICE PIPING
CODE PRESCRIPTIVE VALUE	CONTROLS SHALL ALLOW 110°F SET POINT FOR ALL	CONDUCTIVITY FOR INSULATION SHALL NOT EXCEED 0.27 BTU/INCH/HXFT"2XF
SUPPORTING DOCUMENTATION	SEE PLUMBING DRAWINGS FOR REFERENCE	SEE PLUMBING DRAWINGS FOR REFERENCE

Remeeder House 580 Sutter Ave Brooklyn, NY 11207	
Energy Expenses Without AEGIS	
ConEd SC8 Electric Delivery	\$ 61,213
ESCO Electric Supply	\$ 63,093
N-Grid T-3 Boiler Gas Delivery	\$ 13,255
Direct Energy Boiler Gas Supply	\$ 25,010
	\$ 162,570
Unit Type	CP35D
# Of Units	1
Energy Expenses With AEGIS	
ConEd SC8 Electric Delivery	\$ 41,475
ESCO Electric Supply	\$ 31,839
N-Grid T-3 Boiler Gas Delivery	\$ 8,762
Direct Energy Boiler Gas Supply	\$ 16,123
N-Grid 4-A Cogen Gas Delivery	\$ 8,970
N-Grid 4-A Cogen Gas Supply	\$ 8,164
	\$ 115,333
Gross Savings	\$ 47,238
Cogen Maintenance	\$ (6,242)
Net Savings:	\$ 40,996

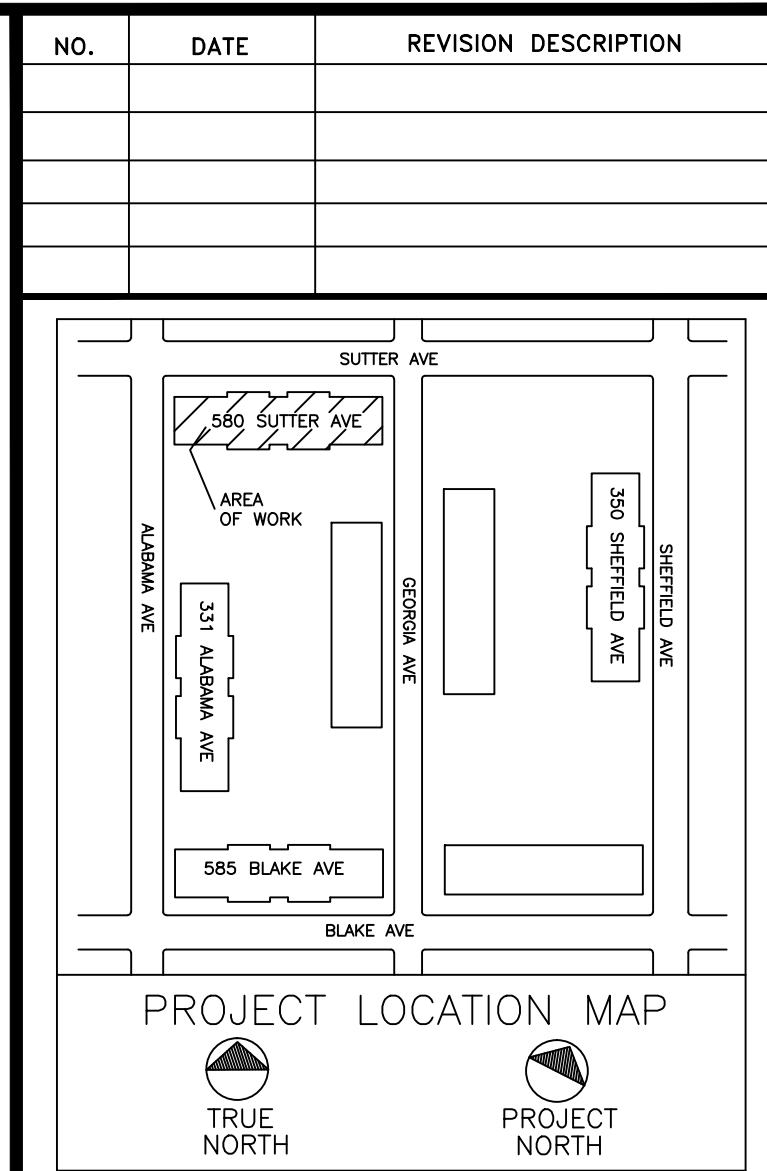

CLIENT:
AEGIS ENERGY SERVICES, INC.
55 JACKSON STREET
HOLYOKE, MA 01040
TEL.: 413-536-1156
FAX: 413-536-1104
ATTN: KEVIN MAY

ALL DRAWINGS ARE TO BE READ NOT SCALED.

STATEMENT:
IT IS A VIOLATION OF THE LAW FOR ANY PERSON, UNLESS ACTING UNDER THE DIRECTION OF A LICENSED ENGINEER/ARCHITECT, TO ALTER IN ANY WAY ANY ITEM ON THESE DRAWINGS. IF AN ITEM BEARING THE SEAL OF AN ENGINEER/ARCHITECT IS ALTERED, THE ALTERING ENGINEER/ARCHITECT SHALL AFFIX TO THIS ITEM THEIR SEAL AND THE NOTATION "ALTERED BY", FOLLOWED BY HIS/HER SIGNATURE AND THE DATE OF SUCH ALTERATION, ALONG WITH A SPECIFIC DESCRIPTION OF THE ALTERATION ON THE DRAWING.

PROPRIETARY STATEMENT:
THE PLANS AND SPECIFICATIONS HEREIN ARE INTENDED FOR THE SUBJECT PROJECT ONLY AND AS A RESULT OF CONTRACTUAL NEGOTIATIONS BETWEEN BECKER ENGINEERING, PC, THESE PLANS AND SPECIFICATIONS WILL BE THE SUBJECT OF A COPYRIGHT PETITION AND MAY NOT BE REVISED OR REUSED BY ANYONE WITHOUT THE WRITTEN AUTHORITY OF BECKER ENGINEERING, PC.

PREPARED BY:
BECKER ENGINEERING, PC
777 SUNRISE HIGHWAY, SUITE 300
LYNBROOK, NY 11563
PHONE: (516) 561-5922
FAX: (516) 823-0219 EMAIL: SUPPORT@BEP.CS
WEB: WWW.BEP.CS

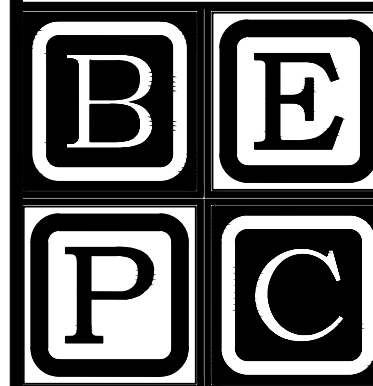

PROJECT
**REMEEDER HOUSE
COGENERATION PROJECT
580 SUTTER AVE
BROOKLYN, NY 11207**

DRAWING TITLE:
ENERGY ANALYSIS

DESIGN BY:	SP	DATE:	08/30/16
DRN BY:	SP	DATE:	08/30/16
CKD BY:	.	DATE:	.
FINAL CKD BY:	.	DATE:	.
SCALE:	AS NOTED	DATE:	
DWG No.	PAGE 2 OF 10		

G-101.00

PROJECT NO.
60-341

B-SCAN:

Electric Usage and Costs With AEGIS 35kW Cogen Plant						
Date	Days	kW Demand	kWh	ConEd SC8 Delivery	ESCO Supply	Total Electric Charges
12/22/2014						
1/21/2015	30	93	27,100	\$ 3,649	\$ 2,908	\$ 6,557
2/20/2015	30	85	23,660	\$ 3,014	\$ 2,539	\$ 5,553
3/22/2015	30	81	22,140	\$ 3,172	\$ 2,376	\$ 5,547
4/22/2015	31	60	13,262	\$ 2,145	\$ 1,423	\$ 3,568
5/21/2015	29	65	14,538	\$ 2,113	\$ 1,560	\$ 3,673
6/22/2015	32	89	19,584	\$ 3,517	\$ 2,101	\$ 5,618
7/22/2015	30	131	44,140	\$ 5,731	\$ 4,736	\$ 10,467
8/22/2015	31	126	43,342	\$ 5,714	\$ 4,651	\$ 10,364
9/23/2015	32	78	21,984	\$ 3,456	\$ 2,359	\$ 5,815
10/22/2015	29	88	24,378	\$ 3,102	\$ 2,616	\$ 5,718
11/22/2015	31	81	22,782	\$ 3,024	\$ 2,445	\$ 5,469
12/22/2015	30	76	19,820	\$ 2,838	\$ 2,127	\$ 4,965
Total:	365	131	296,730	\$ 41,475	\$ 31,839	\$ 73,314

Electric Usage and Costs Without AEGIS 35 kW Cogen Plant						
Date	Days	kW Demand	kWh	ConEd SC8 Delivery	ESCO Supply	Total Electric Charges
12/22/2014						
1/21/2015	30	116	51,040	\$ 5,434	\$ 5,477	\$ 10,910
2/20/2015	30	108	47,600	\$ 4,525	\$ 5,108	\$ 9,632
3/22/2015	30	105	46,080	\$ 5,007	\$ 4,944	\$ 9,951
4/22/2015	31	84	38,000	\$ 3,865	\$ 4,077	\$ 7,942
5/21/2015	29	89	37,680	\$ 3,550	\$ 4,043	\$ 7,593
6/22/2015	32	112	45,120	\$ 5,203	\$ 4,841	\$ 10,044
7/22/2015	30	155	68,080	\$ 7,324	\$ 7,305	\$ 14,629
8/22/2015	31	150	68,080	\$ 7,380	\$ 7,305	\$ 14,685
9/23/2015	32	101	47,520	\$ 5,190	\$ 5,099	\$ 10,289
10/22/2015	29	112	47,520	\$ 4,505	\$ 5,099	\$ 9,604
11/22/2015	31	105	47,520	\$ 4,657	\$ 5,099	\$ 9,756
12/22/2015	30	100	43,760	\$ 4,573	\$ 4,695	\$ 9,269
Total:	365	155	588,000	\$ 61,213	\$ 63,093	\$ 124,305

Date	Days	Fuel Usage Without AEGIS				AEGIS 35 kW Cogen Plant Hours				Fuel Usage W/ AEGIS			Without AEGIS Costs			With AEGIS Costs					
		Total Gas	DHW Gas	Sp. Gas	Ht. Displ. Heat	Cogen Run	Cogen #1 Daily	Cogen Dump	Total Cogen	Suppl. Gas	Cogen Gas	Total Gas	N-Grid T3 Gas Delivery	Direct Energy Boiler Gas Supply	Total Charges	N-Grid T3 Gas Delivery	Direct Energy Boiler Gas Supply	N-Grid 4-A Cogen Gas Delivery	N-Grid 4-A Cogen Gas Supply	Total Charges	
1/5/15																					
2/4/15	30	9,024	1,419	7,605	951	442	24	242	684	7,680	2,784	10,463	\$ 2,431	\$ 4,903	\$ 7,333	\$ 2,087	\$ 4,172	\$ 737	\$ 852	\$ 7,848	
3/7/15	31	8,300	1,466	6,834	982	456	24	251	707	6,911	2,877	9,787	\$ 2,249	\$ 4,509	\$ 6,759	\$ 1,894	\$ 3,755	\$ 762	\$ 833	\$ 7,243	
4/5/15	29	6,804	1,372	5,432	919	427	24	234	661	5,504	2,691	8,195	\$ 1,859	\$ 3,697	\$ 5,555	\$ 1,526	\$ 2,990	\$ 713	\$ 642	\$ 5,871	
5/5/15	30	3,467	1,419	2,048	951	442	24	242	684	2,123	2,784	4,906	\$ 1,008	\$ 1,884	\$ 2,892	\$ 664	\$ 1,153	\$ 737	\$ 681	\$ 3,236	
6/4/15	30	2,049	1,419	630	951	442	24	242	684	705	2,784	3,488	\$ 646	\$ 1,113	\$ 1,759	\$ 278	\$ 383	\$ 737	\$ 507	\$ 1,905	
7/6/15	32	1,703	1,513	190	1,014	471	24	259	730	269	2,969	3,238	\$ 565	\$ 925	\$ 1,490	\$ 135	\$ 146	\$ 786	\$ 610	\$ 1,678	
8/5/15	30	1,449	1,449	-	971	450	24	234	684	78	2,784	2,862	\$ 492	\$ 787	\$ 1,279	\$ 68	\$ 42	\$ 737	\$ 543	\$ 1,391	
9/4/15	30	1,382	1,382	-	926	431	24	253	684	70	2,784	2,854	\$ 475	\$ 751	\$ 1,226	\$ 66	\$ 38	\$ 737	\$ 577	\$ 1,418	
10/5/15	31	1,473	1,473	-	987	458	24	249	707	78	2,877	2,954	\$ 502	\$ 800	\$ 1,302	\$ 70	\$ 42	\$ 762	\$ 648	\$ 1,522	
11/6/15	32	2,689	1,513	1,176	1,014	471	24	259	730	1,255	2,969	4,224	\$ 817	\$ 1,461	\$ 2,278	\$ 450	\$ 682	\$ 786	\$ 703	\$ 2,622	
12/6/15	30	3,278	1,419	1,859	951	442	24	242	684	1,934	2,784	4,717	\$ 960	\$ 1,781	\$ 2,741	\$ 616	\$ 1,050	\$ 737	\$ 734	\$ 3,138	
1/5/16	30	4,416	1,419	2,997	951	442	24	242	684	3,072	2,784	5,855	\$ 1,251	\$ 2,399	\$ 3,650	\$ 907	\$ 1,669	\$ 737	\$ 834	\$ 4,147	
Total:	365	46,034	17,263	28,771	11,566	5,372		2,950	8,322	29,676	33,871	63,547	\$ 13,255	\$ 25,010	\$ 38,265	\$ 8,762	\$ 16,123	\$ 8,970	\$ 8,164	\$ 42,018	

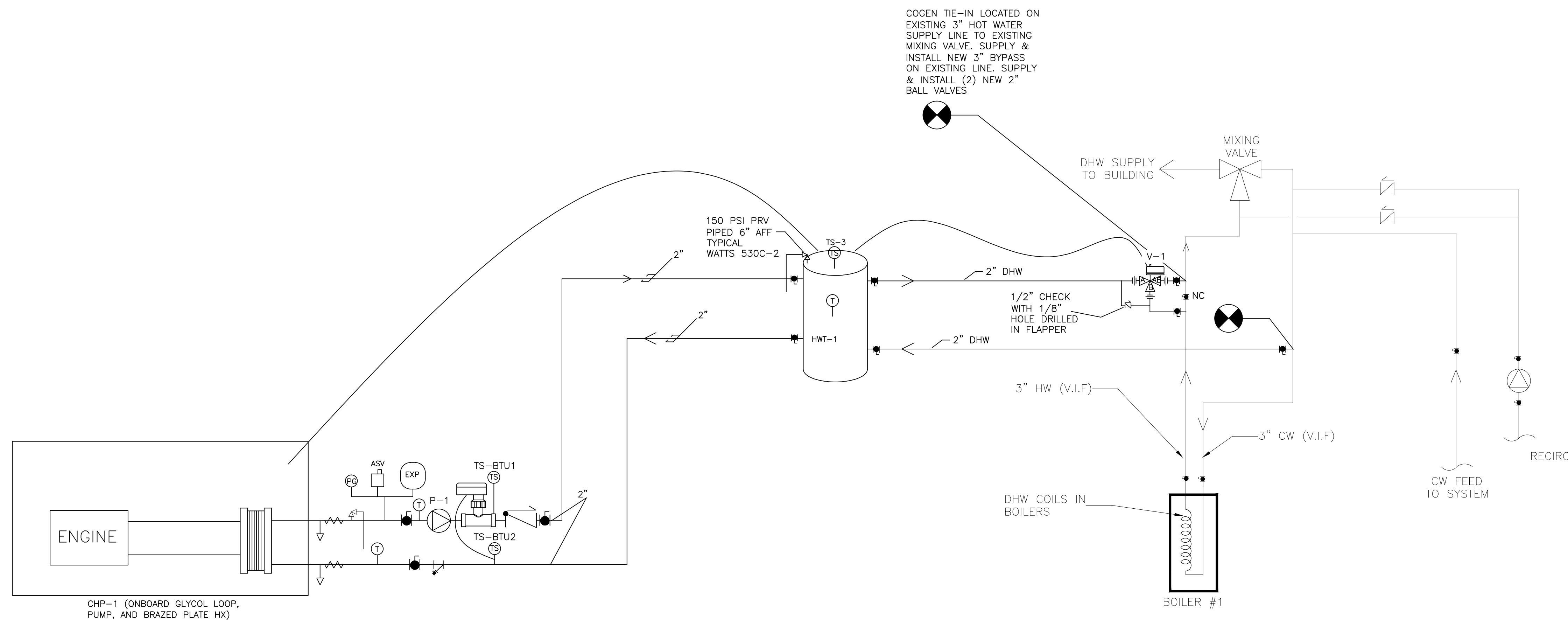

CHP-1 (ONBOARD GLYCOL LOOP, PUMP, AND BRAZED PLATE HX)

DHW STORAGE TANK SCHEDULE HWT-1	
MANUFACTURER	AO SMITH
WEIGHT	~800 LBS
CAPACITY	120 GAL
ORIENTATION	VERTICAL
LINING	GLASS
DIAMETER	28"
HEIGHT	62"
MODEL	TJV-120M
MANWAY	N/A
MAX PRESSURE	160 PSI
PRESSURE RELIEF VALVE	WATTS530C-2 SET AT 150 PSI

COGENERATION SCHEDULE CHP-1	
DESIGN MANUFACTURER	YANMAR
FUEL	NATURAL GAS
FUEL INPUT	408 CFH
THERMAL OUTPUT	202,000 BTU/H
ELECTRICAL OUTPUT	35 KW, 208V
POWER GENERATOR	DG GENERATOR - INVERTER
ACOUSTIC LEVEL	64 dB (A)
VIBRATION ISOLATION	YES
CONTROLS	MICROPROCESSOR BASED
UNIT WEIGHT	3,374 LBS
MODEL	CP35D1
NOMINAL INLET TEMP	167 F
NOMINAL OUTLET TEMP	176 F
NOMINAL WATER FLOW RATE	39.6 GPM

TEMPERATURE SENSOR SCHEDULE			
TS NO.	SERVICE	SENSOR MODEL NO.	WELL TYPE
TS-BTU1	COGEN SUPPLY	MAMAC TE-703-C-5A	AT-225
TS-BTU2	COGEN LOOP LEAVING H.X.-1	MAMAC TE-703-C-5A	AT-225
TS-3	TANK TEMPERATURE	MAMAC TE-703-C-5A	AT-225

PUMP SCHEDULE						
PUMP NO.	SERVICE	FLOW	HEAD	PUMP H.P.	PHASE	PUMP MODEL
P-1	COGEN LOOP	40 GPM	17 FT	1/2 HP	1 PH	GRUNDFOS UPS 43-100 SF

CONTROL VALVE SCHEDULE						
VALVE NO.	SERVICE	FLOW TYPE	SIZE	VOLTAGE	VALVE MODEL	ACTUATOR
V-1	BUILDING DHW LOOP	NORMALLY B	2"	24 V	BARBER COLMAN VA2313-526-9-67	MA40-7043 ON/OFF

- NOTES:
- ALL PIPE TO BE COPPER "L" UNLESS OTHERWISE NOTED
 - COGEN HEAT DISSIPATION LOOP TO BE 40% PROP. GLYCOL. ALL FILLING OF GLYCOL LOOP BY AEGIS.
 - CONTRACTOR SHALL PROTECT FROM HARM AND MAINTAIN ALL EXISTING EQUIPMENT, PLANT, FACILITY, ETC. TO REMAIN.

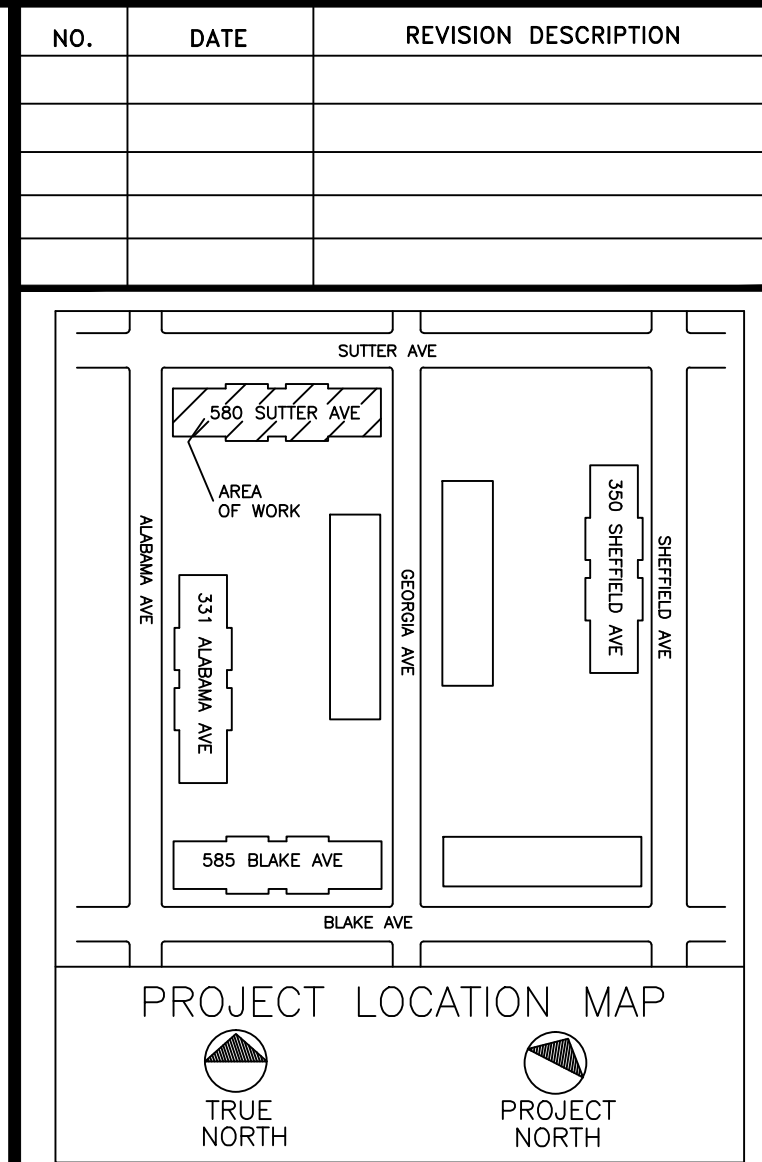

CLIENT:
AEGIS ENERGY SERVICES, INC
 55 JACKSON STREET
 HOLYOKE, MA 01040
 TEL: 413-536-1156
 FAX: 413-536-1104
 ATTN: KEVIN MAY

ALL DRAWINGS ARE TO BE READ NOT SCALED.

STATEMENT:
 IT IS A VIOLATION OF THE LAW FOR ANY PERSON, UNLESS ACTING UNDER THE DIRECTION OF A LICENSED ENGINEER/ARCHITECT, TO ALTER IN ANY WAY, ANY ITEM ON THESE DRAWINGS. IF AN ITEM BEARING THE SEAL OF AN ENGINEER/ARCHITECT IS ALTERED, THE ALTERING ENGINEER/ARCHITECT SHALL AFFIX TO THIS ITEM THEIR SEAL AND THE NOTATION "ALTERED BY", FOLLOWED BY HIS/HER SIGNATURE AND THE DATE OF SUCH ALTERATION, ALONG WITH A SPECIFIC DESCRIPTION OF THE ALTERATION ON THE DRAWING.

PROPRIETARY STATEMENT:
 THE PLANS AND SPECIFICATIONS HEREIN ARE INTENDED FOR THE SUBJECT PROJECT ONLY AND AS A RESULT OF CONTRACTUAL NEGOTIATIONS BETWEEN BECKER ENGINEERING, PC, THESE PLANS AND SPECIFICATIONS WILL BE THE SUBJECT OF A COPYRIGHT PETITION AND MAY NOT BE REVISED OR REUSED BY ANYONE WITHOUT THE WRITTEN AUTHORITY OF BECKER ENGINEERING, PC.

PREPARED BY:
BECKER ENGINEERING, PC
 777 SUNRISE HIGHWAY, SUITE 300
 LYNBROOK, NY 11563
 PHONE: (516) 561-5922
 FAX: (516) 823-0219 EMAIL:
 SUPPORT@BEPC.US
 WEB: WWW.BEPC.US

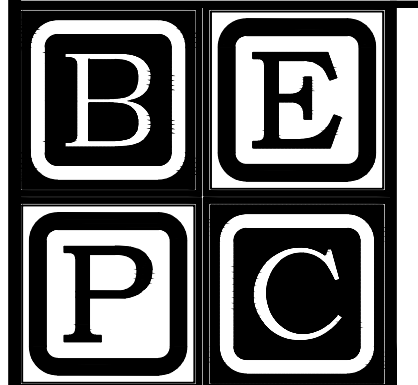

PROJECT
**REMEEDER HOUSE
 COGENERATION PROJECT**
 580 SUTTER AVE
 BROOKLYN, NY 11207

DRAWING TITLE:
**MECHANICAL/HVAC
 SCHEDULES & FLOW
 DIAGRAM**

DESIGN BY:	SP	DATE:	08/30/16
DRN BY:	SP	DATE:	08/30/16
CKD BY:	.	DATE:	.
FINAL CKD BY:	.	DATE:	.
SCALE:	AS NOTED	DATE:	
DWG No.	PAGE 3 OF 10		

M-101.00

PROJECT NO.
 60-341

B-SCAN:

NO.	DATE	REVISION DESCRIPTION

CLIENT:
AEGIS ENERGY SERVICES, INC
 55 JACKSON STREET
 HOLYOKE, MA 01040
 TEL.: 413-536-1156
 FAX: 413-536-1104
 ATTN: KEVIN MAY

ALL DRAWINGS ARE TO
 BE READ NOT SCALED.

STATEMENT:
 IT IS A VIOLATION OF THE LAW FOR ANY PERSON, UNLESS ACTING UNDER THE DIRECTION OF A LICENSED ENGINEER/ARCHITECT, TO ALTER IN ANY WAY, ANY ITEM ON THESE DRAWINGS. IF AN ITEM BEARING THE SEAL OF AN ENGINEER/ARCHITECT IS ALTERED, THE ALTERING ENGINEER/ARCHITECT SHALL AFFIX TO THIS ITEM THEIR SEAL AND THE NOTATION "ALTERED BY", FOLLOWED BY HIS/HER SIGNATURE AND THE DATE OF SUCH ALTERATION, ALONG WITH A SPECIFIC DESCRIPTION OF THE ALTERATION ON THE DRAWING.

PROPRIETARY STATEMENT:
 THE PLANS AND SPECIFICATIONS HEREIN ARE INTENDED FOR THE SUBJECT PROJECT ONLY AND AS A RESULT OF CONTRACTUAL NEGOTIATIONS BETWEEN BECKER ENGINEERING, PC, THESE PLANS AND SPECIFICATIONS WILL BE THE SUBJECT OF A COPYRIGHT PETITION AND MAY NOT BE REVISED OR REUSED BY ANYONE WITHOUT THE WRITTEN AUTHORITY OF BECKER ENGINEERING, PC.

PREPARED BY:
BECKER ENGINEERING, PC
 777 SUNRISE HIGHWAY, SUITE 300
 LYNBROOK, NY 11563
 PHONE: (516) 561-5922
 FAX: (516) 823-0219 EMAIL:
 SUPPORT@BEPC.US
 WEB: WWW.BEPC.US

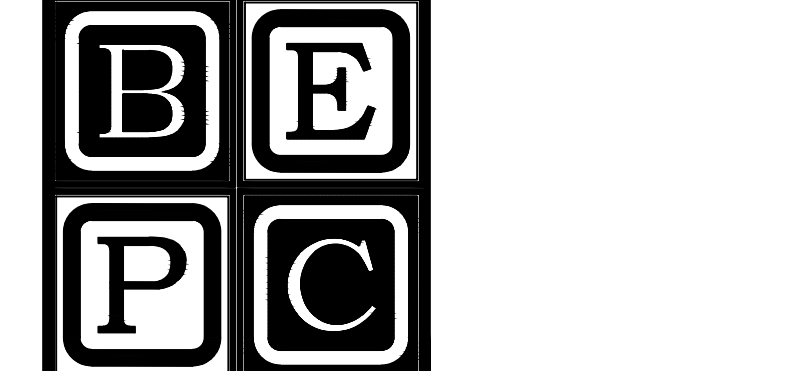

PROJECT
**REMEEDER HOUSE
 COGENERATION PROJECT
 580 SUTTER AVE
 BROOKLYN, NY 11207**

DRAWING TITLE:
**CELLAR MECHANICAL
 PLAN**

DESIGN BY:	SP	DATE:	08/30/16
DRN BY:	SP	DATE:	08/30/16
CKD BY:	.	DATE:	.
FINAL CKD BY:	.	DATE:	.
SCALE:	AS NOTED	DATE:	.
DWG No.	PAGE 4 OF 10		

M-201.00

PROJECT NO.
60-341

B-SCAN:

- NOTES:**
- (CG-1) YANMAR 35 KW CP35D1 COGENERATION UNIT, PROVIDED AND SET BY AEGIS, MECHANICAL CONTRACTOR TO MAKE CONNECTIONS UP TO UNIT. SEE COMBUSTION EXHAUST, AND DUCT DETAILS ON SHEET M-301.
- (F-1 & F-2) FANTECH FKD-16XL OR SIMILAR, PROVIDED BY AEGIS, MECHANICAL CONTRACTOR TO INSTALL. INSTALL WITH VIBRATION ISOLATORS FROM CEILING AND USE FLEXIBLE CONNECTORS ON INLET AND OUTLET.
- (MD-1) REMOVE EXISTING DOOR AND INSTALL NEW PLATE ACROSS DOOR OPENING. INSTALL NEW 36X48" COMBINATION LOUVER/DAMPER DAMPER PROVIDED BY AEGIS. INSTALL EXISTING BOILER INTAKE FAN FROM OTHER LOUVER. SEE M-301 FOR DETAILS.
- (CC-1) INSTALL NEW CONDENSATE CONDITIONER AXIOM MODEL NC-1. MOUNT ON GROUND, CONNECT FLEX HOSE FROM UNIT DIRECTLY TO INLET. RUN COPPER 3/4" PIPING TO NEAREST FLOOR DRAIN.
- ① TIE COGEN COMBUSTION EXHAUST INTO EXISTING CHIMNEY. PENETRATE THROUGH CHIMNEY AND SEAL WITH HIGH TEMP RTV. SEE M-301 FOR DETAILS.
 - ② (2 PLACES) PENETRATE AND TIE INTO EXISTING LOUVER PLENUM FOR COGEN MECHANICAL EXHAUST. REMOVE EXISTING BOILER INTAKE FAN AND INSTALL ON DOOR FRAME INTAKE FROM BOILER PIT. SEE M-301 FOR DETAILS.
- * EXISTING STEAM SYSTEM TO REMAIN UNCHANGED.

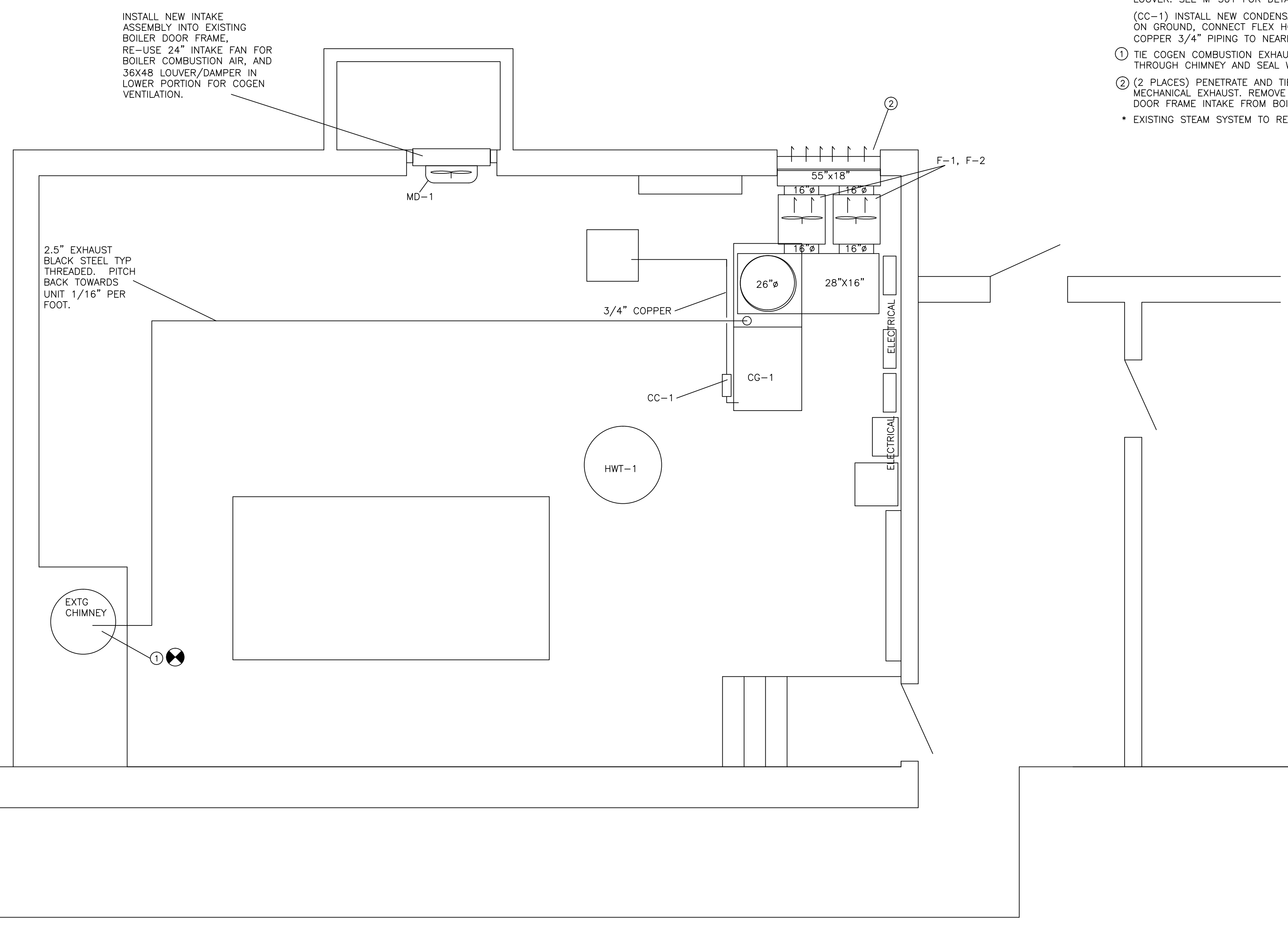

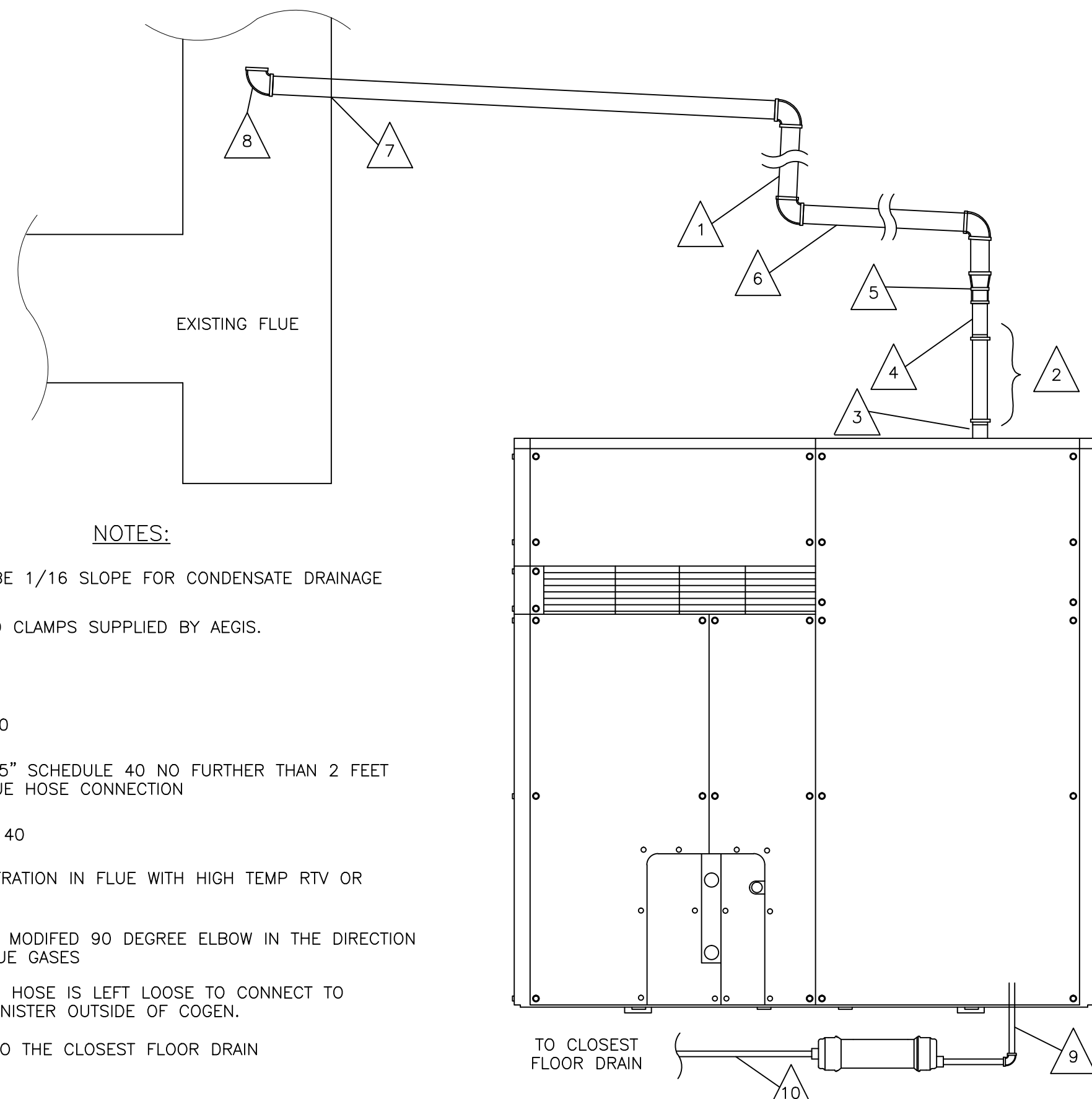

NOTES:

- 1 FLUE PIPE TO BE 1/16 SLOPE FOR CONDENSATE DRAINAGE
- 2 BLUE HOSE AND CLAMPS SUPPLIED BY AEGIS.
- 3 2" CONNECTION
- 4 2" SCHEDULE 40
- 5 INCREASE TO 2.5" SCHEDULE 40 NO FURTHER THAN 2 FEET AWAY FROM BLUE HOSE CONNECTION
- 6 2.5" SCHEDULE 40
- 7 FIRESTOP PENETRATION IN FLUE WITH HIGH TEMP RTV OR EQUIVALENT
- 8 TERMINATE WITH MODIFIED 90 DEGREE ELBOW IN THE DIRECTION OF EXISTING FLUE GASES
- 9 INTERNAL BLACK HOSE IS LEFT LOOSE TO CONNECT TO CONDENSATE CANISTER OUTSIDE OF COGEN.
- 10 3/4" COPPER TO THE CLOSEST FLOOR DRAIN

1
M-301 **COGENERATION FLUE DETAIL**
SCALE: NTS

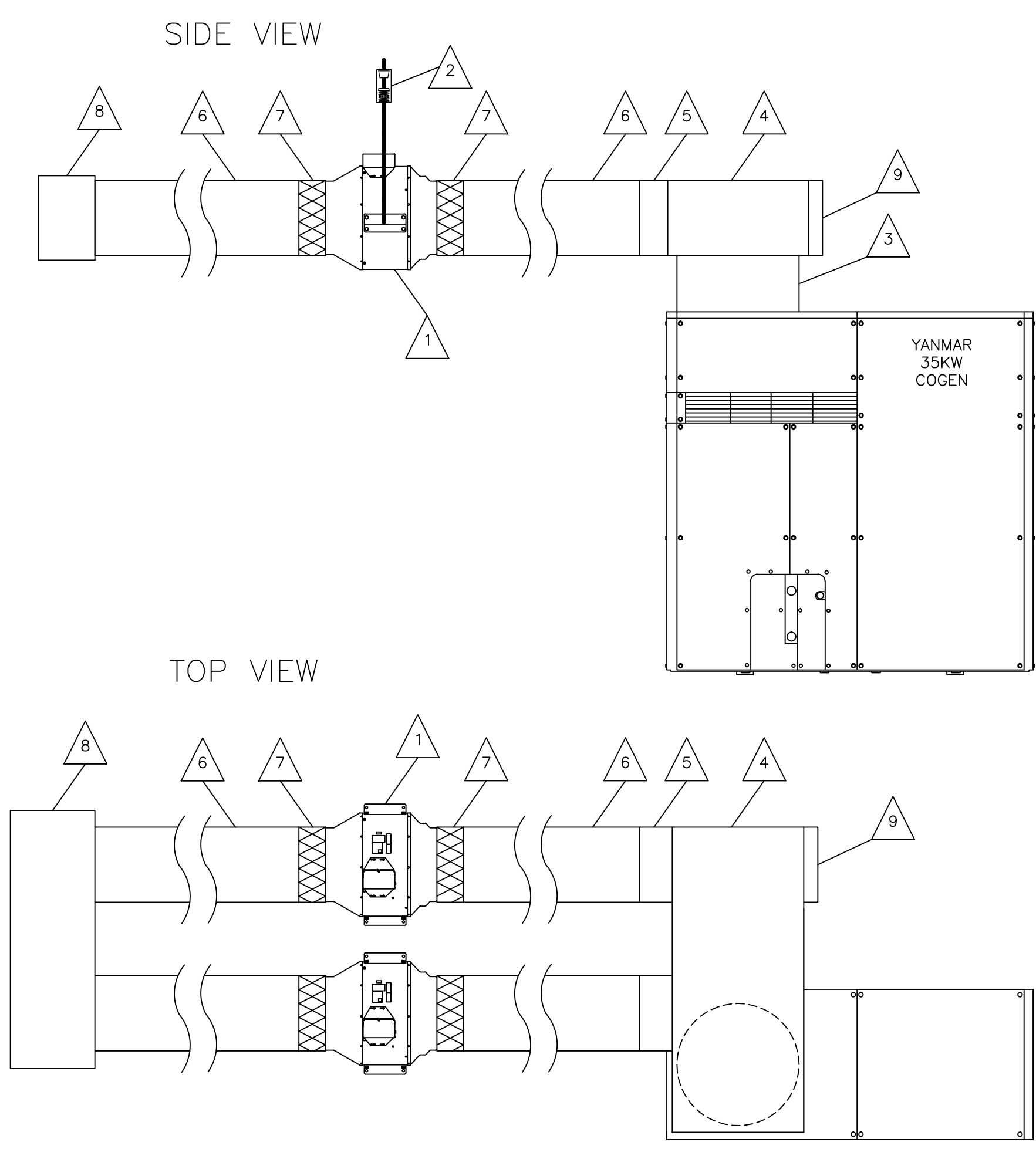

NOTES:

- 1 FANTECH 16XL FAN SUPPLIED BY AEGIS, INSTALLED BY DUCT WORK CONTRACTOR. 16" CONNECTIONS
 - 2 VIBRATION HANGARS SUPPLIED & INSTALLED BY DUCTWORK CONTRACTOR.
 - 3 26" ROUND CONNECTION
 - 4 X"L X 28"W X 16"H. **X DIMENSION TO BE DETERMINED IN FIELD
 - 5 16" ROUND CONNECTION
 - 6 16" ROUND DUCT
 - 7 16" FLEX CONNECTION TO FANTECH 16XL FAN
 - 8 55"L X 12"W X 18"H
 - 9 16" RETURN GRILLE SUPPLIED & INSTALLED BY DUCTWORK CONTRACTOR
- *** ALL DUCTWORK IS TO BE 26 GAUGE SHEET METAL

2
M-301 **COGENERATION DUCT DETAIL**
SCALE: NTS

NO.	DATE	REVISION DESCRIPTION

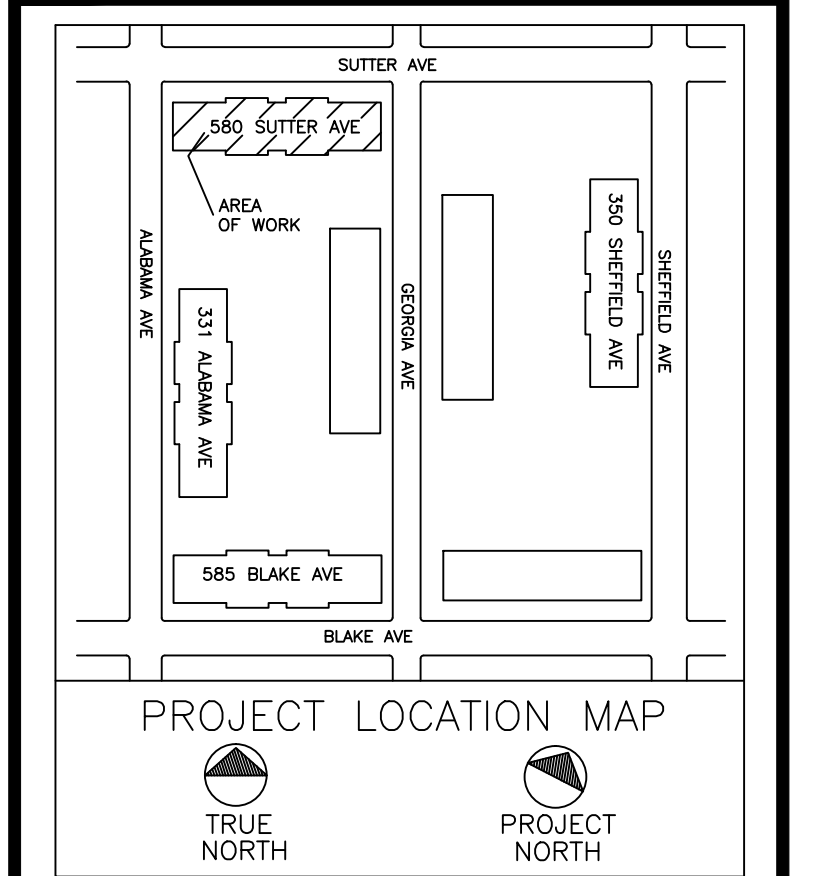

CLIENT:
AEGIS ENERGY SERVICES, INC
 55 JACKSON STREET
 HOLYOKE, MA 01040
 TEL: 413-536-1156
 FAX: 413-536-1104
 ATTN: KEVIN MAY

ALL DRAWINGS ARE TO BE READ NOT SCALED.

STATEMENT:
 IT IS A VIOLATION OF THE LAW FOR ANY PERSON, UNLESS ACTING UNDER THE DIRECTION OF A LICENSED ENGINEER/ARCHITECT, TO ALTER IN ANY WAY, ANY ITEM ON THESE DRAWINGS. IF AN ITEM BEARING THE SEAL OF AN ENGINEER/ARCHITECT IS ALTERED, THE ALTERING ENGINEER/ARCHITECT SHALL AFFIX TO THIS ITEM THEIR SEAL AND THE NOTATION "ALTERED BY", FOLLOWED BY HIS/HER SIGNATURE AND THE DATE OF SUCH ALTERATION, ALONG WITH A SPECIFIC DESCRIPTION OF THE ALTERATION ON THE DRAWING.

PROPRIETARY STATEMENT:
 THE PLANS AND SPECIFICATIONS HEREIN ARE INTENDED FOR THE SUBJECT PROJECT ONLY AND AS A RESULT OF CONTRACTUAL NEGOTIATIONS BETWEEN BECKER ENGINEERING, PC, THESE PLANS AND SPECIFICATIONS WILL BE THE SUBJECT OF A COPYRIGHT PETITION AND MAY NOT BE REVISED OR REUSED BY ANYONE WITHOUT THE WRITTEN AUTHORITY OF BECKER ENGINEERING, PC.

PREPARED BY:
BECKER ENGINEERING, PC
 777 SUNRISE HIGHWAY, SUITE 300
 LYNBROOK, NY 11563
 PHONE: (516) 561-5922
 FAX: (516) 823-0219 EMAIL: SUPPORT@BEPC.US
 WEB: WWW.BEPC.US

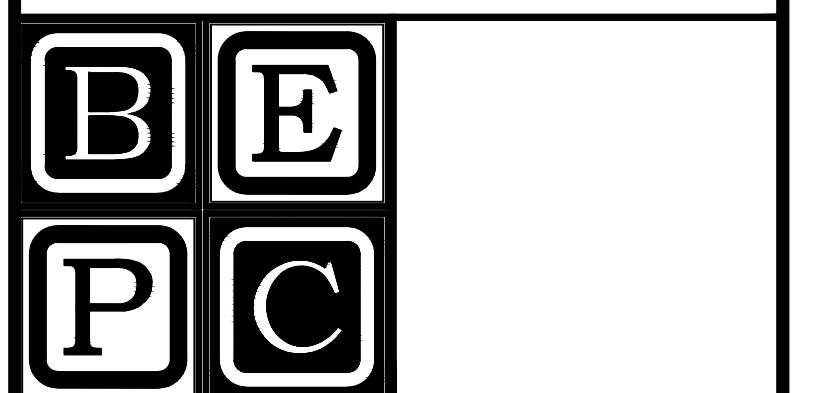

PROJECT
**REMEEDER HOUSE
 COGENERATION PROJECT
 580 SUTTER AVE
 BROOKLYN, NY 11207**

DRAWING TITLE:
**MECHANICAL/
 HVAC DETAILS**

DESIGN BY:	SP	DATE:	08/30/16
DRN BY:	SP	DATE:	08/30/16
CKD BY:	.	DATE:	.
FINAL CKD BY:	.	DATE:	.
SCALE:	AS NOTED	DATE:	.
DWG No.	PAGE 5 OF 10		

M-301.00

PROJECT NO.
60-341

B-SCAN:

NOTES:

(CG-1) PROVIDED AND SET BY AEGIS, PLUMBER TO MAKE CONNECTIONS UP TO UNIT. INSTALL FLEX CONNECTORS SUPPLIED BY AEGIS AT UNIT CONNECTIONS. INSTALL PIPING TRAIN PER DETAILS ON P-201 IN CEILING. INSTALL GAS UNION AND SHUTOFF VALVE ON UNIT.

(HWT-1) PROVIDED AND SET BY AEGIS, PLUMBER TO MAKE CONNECTIONS UP TO TANKS. INSTALL VALVES AT TANK ON ALL LINES. INSTALL AEGIS SUPPLIED PRV TO TANK AND PIPE TO FLOOR. INSTALL SENSOR AND GAGE PROVIDED BY AEGIS ON TANK. INSTALL 1" DRAIN ON TANK. SEE M-101 & P-201 FOR DETAILS.

(V-1) VALVE AND UNIONS PROVIDED BY AEGIS. ALL OTHER COMPONENTS PROVIDED BY PLUMBER. TIE INTO EXISTING LINES AS SHOWN. INCREASE PIPING SIZE TO 2.5" AFTER 3-WAY VALVE.

(GM-CG) NEW RM-2000 GAS METER PROVIDED BY AEGIS, INSTALLED BY PLUMBER. PLUMBER TO PROVIDE MATCHING FLANGES AND GASKETS.

- ① GAS LINE CONTINUES BELOW <<NOTE SCALE CHANGE ON DRAWING BELOW>>
- ② TIE INTO EXISTING 3" HOT LINE OF DHW SYSTEM. 2 PLACES. USE 2" PIPING FOR TAPS AND INTO 3-WAY VALVE. SEE M-101 FOR DETAILS.
- ③ TIE INTO EXISTING 3" COLD LINE OF DHW SYSTEM. 2" LINE WITH VALVE. SEE M-201 FOR DETAILS.

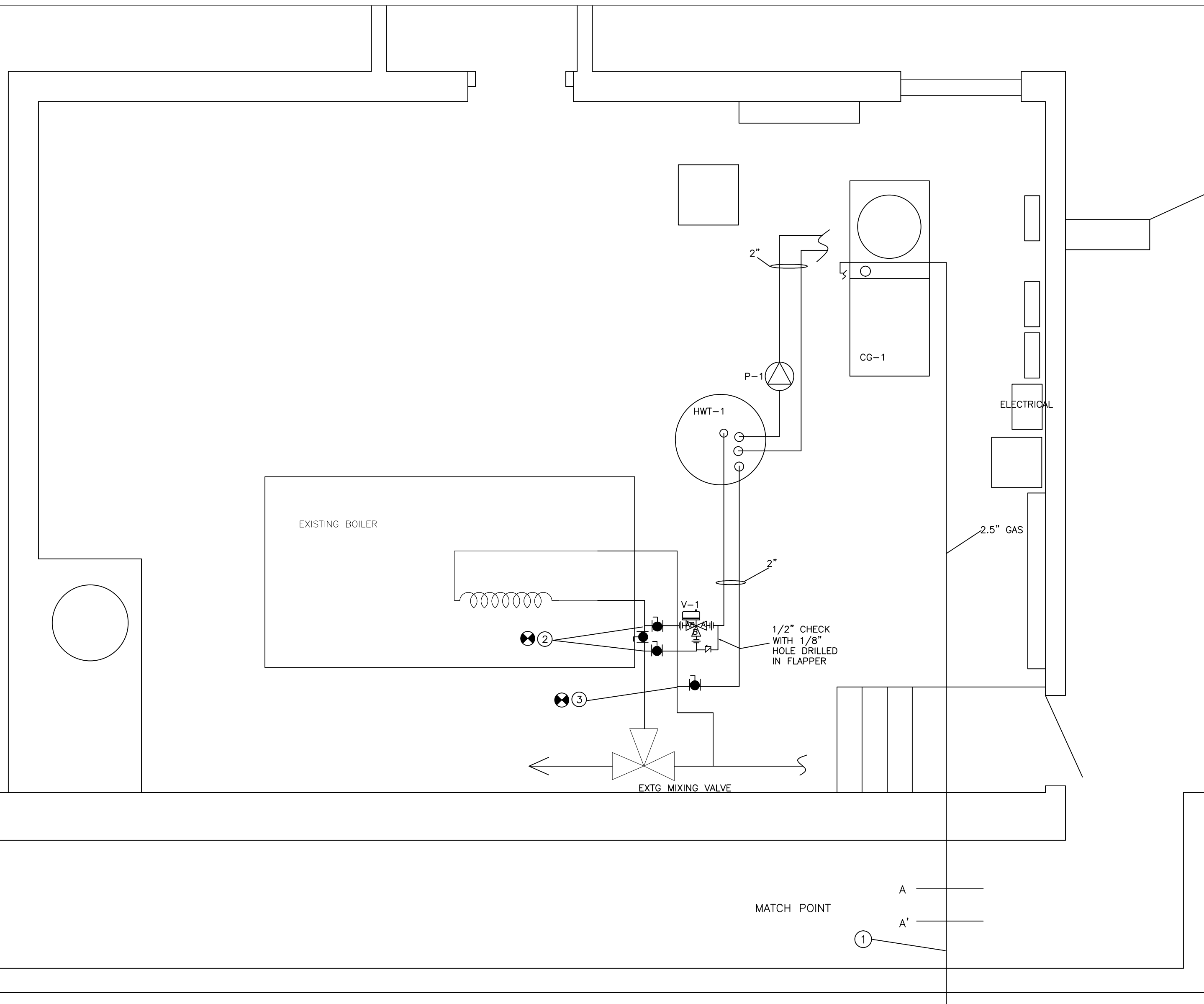

1
P-101
CELLAR PLUMBING PLAN
SCALE: 3/8"=1'-0"

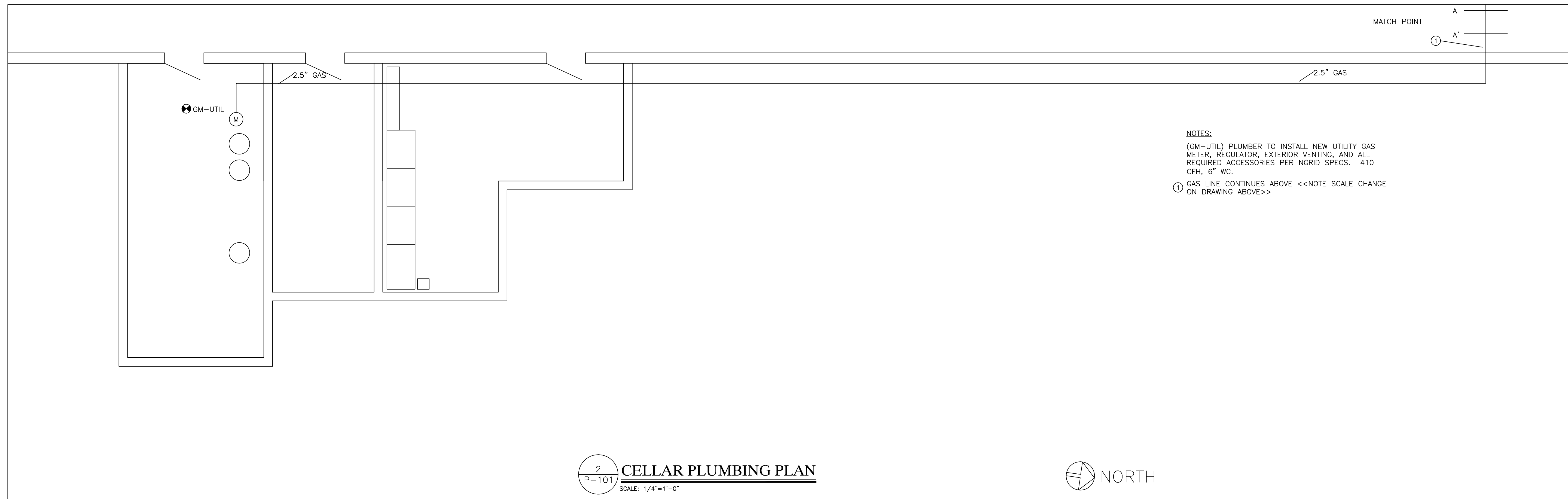

NOTES:

(GM-UTIL) PLUMBER TO INSTALL NEW UTILITY GAS METER, REGULATOR, EXTERIOR VENTING, AND ALL REQUIRED ACCESSORIES PER NGRID SPECS. 410 CFH, 6" WC.

- ① GAS LINE CONTINUES ABOVE <<NOTE SCALE CHANGE ON DRAWING ABOVE>>

2
P-101
CELLAR PLUMBING PLAN
SCALE: 1/4"=1'-0"



NO.	DATE	REVISION DESCRIPTION

PROJECT LOCATION MAP

TRUE NORTH
PROJECT NORTH

CLIENT:
AEGIS ENERGY SERVICES, INC
55 JACKSON STREET
HOLYOKE, MA 01040
TEL: 413-536-1156
FAX: 413-536-1104
ATTN: KEVIN MAY

ALL DRAWINGS ARE TO BE READ NOT SCALED.

STATEMENT:
IT IS A VIOLATION OF THE LAW FOR ANY PERSON, UNLESS ACTING UNDER THE DIRECTION OF A LICENSED ENGINEER/ARCHITECT, TO ALTER IN ANY WAY, ANY ITEM ON THESE DRAWINGS. IF AN ITEM BEARING THE SEAL OF AN ENGINEER/ARCHITECT IS ALTERED, THE ALTERING ENGINEER/ARCHITECT SHALL AFFIX TO THIS ITEM THEIR SEAL AND THE NOTATION "ALTERED BY", FOLLOWED BY HIS/HER SIGNATURE AND THE DATE OF SUCH ALTERATION, ALONG WITH A SPECIFIC DESCRIPTION OF THE ALTERATION ON THE DRAWING.

PROPRIETARY STATEMENT:
THE PLANS AND SPECIFICATIONS HEREIN ARE INTENDED FOR THE SUBJECT PROJECT ONLY AND AS A RESULT OF CONTRACTUAL NEGOTIATIONS BETWEEN BECKER ENGINEERING, PC, THESE PLANS AND SPECIFICATIONS WILL BE THE SUBJECT OF A COPYRIGHT PETITION AND MAY NOT BE REVISED OR REUSED BY ANYONE WITHOUT THE WRITTEN AUTHORITY OF BECKER ENGINEERING, PC.

PREPARED BY:
BECKER ENGINEERING, PC
777 SUNRISE HIGHWAY, SUITE 300
LYNBROOK, NY 11563
PHONE: (516) 561-5922
FAX: (516) 823-0219 EMAIL: SUPPORT@BEPC.US
WEB: WWW.BEPC.US

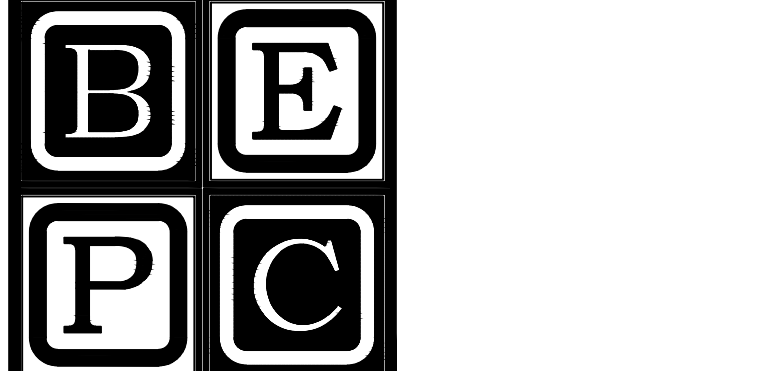

PROJECT
REMEEDER HOUSE
COGENERATION PROJECT
580 SUTTER AVE
BROOKLYN, NY 11207

DRAWING TITLE:
PLUMBING/GAS
PIPING PLAN

DESIGN BY:	SP	DATE:	08/30/16
DRN BY:	SP	DATE:	08/30/16
CKD BY:	.	DATE:	.
FINAL CKD BY:	.	DATE:	.
SCALE:	AS NOTED	DATE:	.
DWG No.	PAGE 6 OF 10		

P-101.00

PROJECT NO.
60-341

B-SCAN:

- NOTES:**
- 1 INSTALL UNION AND VALVE AT COGEN. DO NOT EXCEED MORE THAN 2' OF 1" PIPING
 - 2 DO NOT INSTALL ANY PIPING ABOVE RADIATOR FAN ON TOP OF THE COGEN.
 - 3 MINIMUM 8" REQUIRED OFF TOP OF MACHINE FOR ANY PIPING.
 - 4 MINIMUM 2" REQUIRED OFF SIDE OF COGEN.
 - 5 REDUCE FROM 2.5" TO 1"

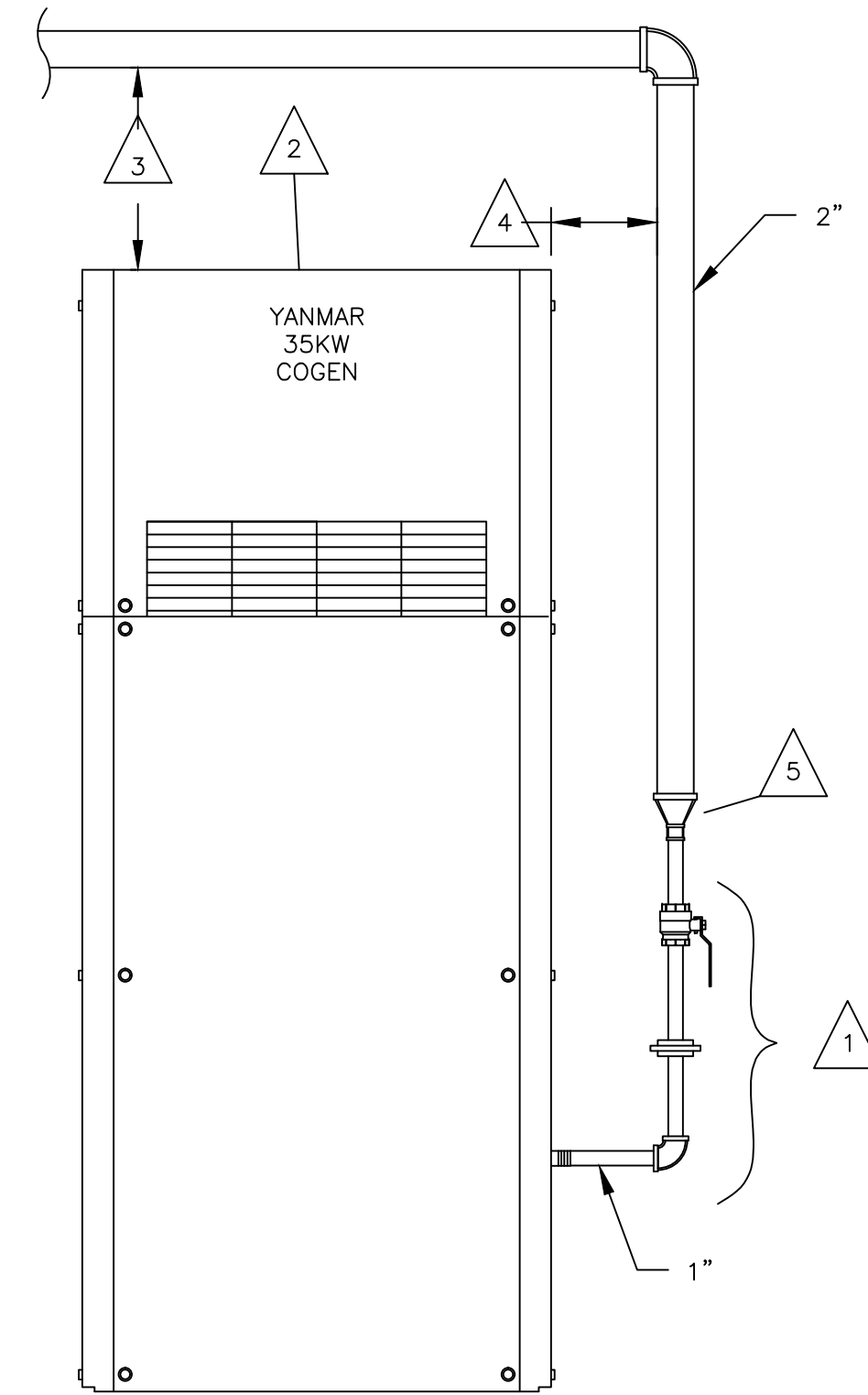

1 COGENERATION GAS CONNECTION DETAILS
SCALE: NTS

- NOTES:**
- 1 PROVIDED BY AEGIS AS ASSEMBLY. MECHANICAL CONTRACTOR RESPONSIBLE FOR MAKING CONNECTIONS.
 - 2 DO NOT INSTALL ANY PIPING ABOVE RADIATOR FAN ON TOP OF THE COGEN.
 - 3 MINIMUM 8" REQUIRED OFF TOP OF MACHINE FOR ANY PIPING.
 - 4 MINIMUM 4" REQUIRED OFF SIDE OF COGEN.
 - 5 DO NOT ALTER THE AMOUNT OF LENGTH BETWEEN THE BTU METER AND BALL VALVE.
 - 6 PIPE PRESSURE RELIEF 6" ABOVE FINISHED FLOOR. DO NOT OBSTRUCT COGEN SERVICE CLEARANCES.

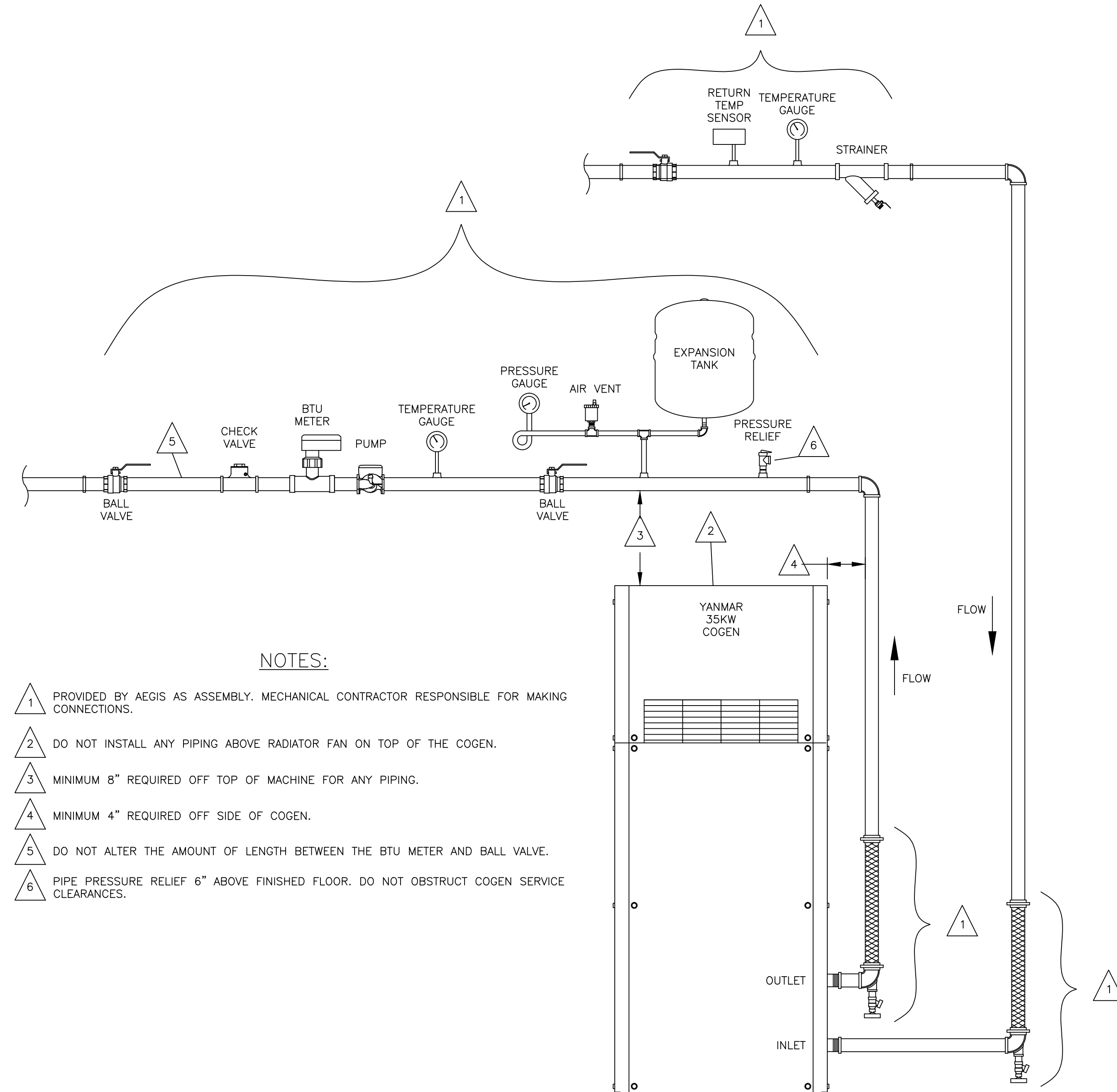

2 COGENERATION WATER PIPING DETAIL
SCALE: NTS

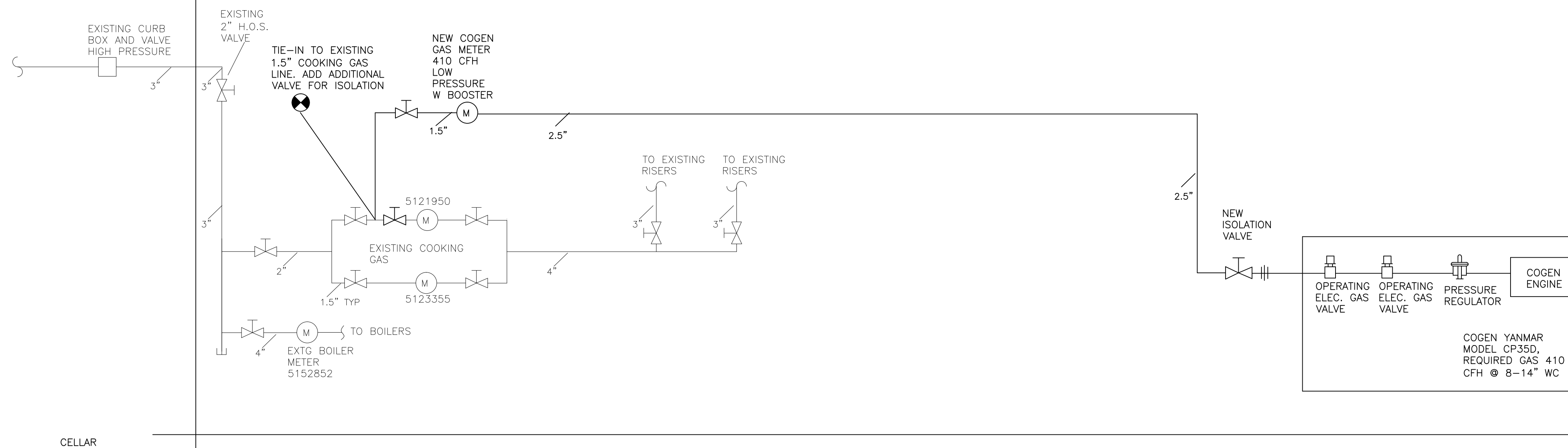

3 COGENERATION GAS RISER DIAGRAM
SCALE: NTS

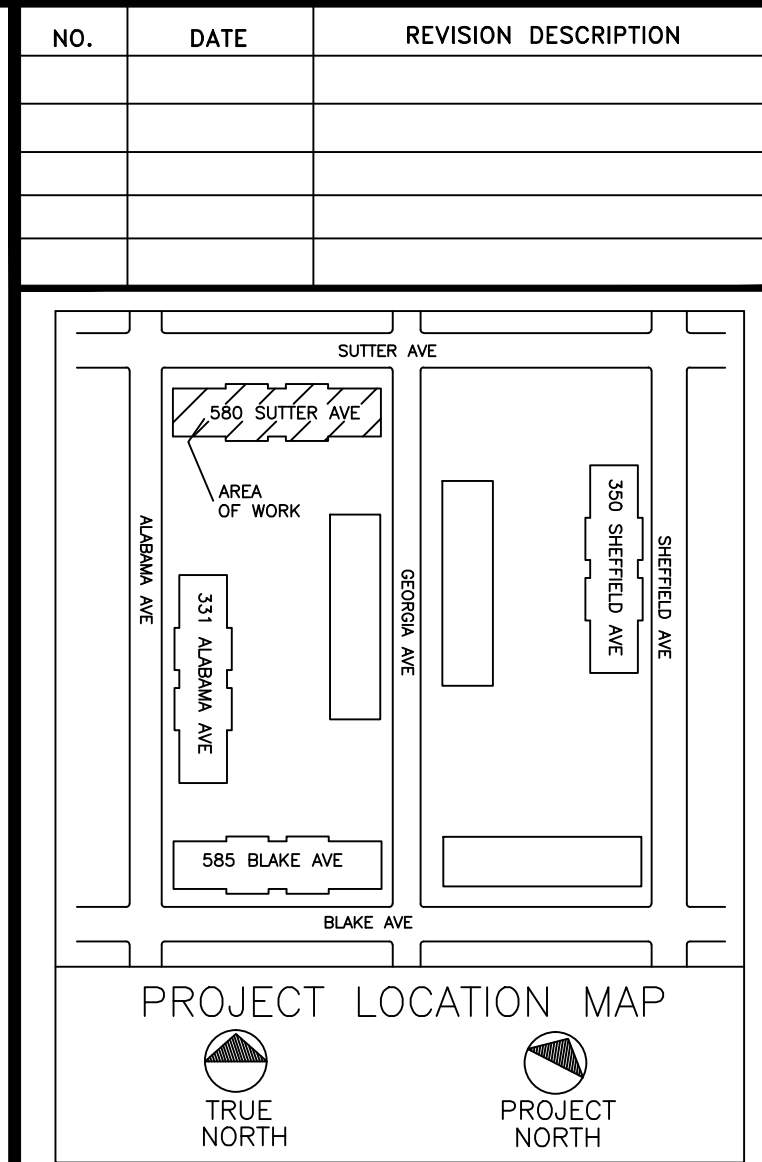

CLIENT:
AEGIS ENERGY SERVICES, INC
 55 JACKSON STREET
 HOLYOKE, MA 01040
 TEL: 413-536-1156
 FAX: 413-536-1104
 ATTN: KEVIN MAY

ALL DRAWINGS ARE TO BE READ NOT SCALED.

STATEMENT:
 IT IS A VIOLATION OF THE LAW FOR ANY PERSON, UNLESS ACTING UNDER THE DIRECTION OF A LICENSED ENGINEER/ARCHITECT, TO ALTER IN ANY WAY, ANY ITEM ON THESE DRAWINGS. IF AN ITEM BEARING THE SEAL OF AN ENGINEER/ARCHITECT IS ALTERED, THE ALTERING ENGINEER/ARCHITECT SHALL AFFIX TO THIS ITEM THEIR SEAL AND THE NOTATION "ALTERED BY", FOLLOWED BY HIS/HER SIGNATURE AND THE DATE OF SUCH ALTERATION, ALONG WITH A SPECIFIC DESCRIPTION OF THE ALTERATION ON THE DRAWING.

PROPRIETARY STATEMENT:
 THE PLANS AND SPECIFICATIONS HEREIN ARE INTENDED FOR THE SUBJECT PROJECT ONLY AND AS A RESULT OF CONTRACTUAL NEGOTIATIONS BETWEEN BECKER ENGINEERING, PC, THESE PLANS AND SPECIFICATIONS WILL BE THE SUBJECT OF A COPYRIGHT PETITION AND MAY NOT BE REVISED OR REUSED BY ANYONE WITHOUT THE WRITTEN AUTHORITY OF BECKER ENGINEERING, PC.

PREPARED BY:
BECKER ENGINEERING, PC
 777 SUNRISE HIGHWAY, SUITE 300
 LYNBROOK, NY 11563
 PHONE: (516) 561-5922
 FAX: (516) 823-0219 EMAIL: SUPPORT@BEPC.US
 WEB: WWW.BEPC.US

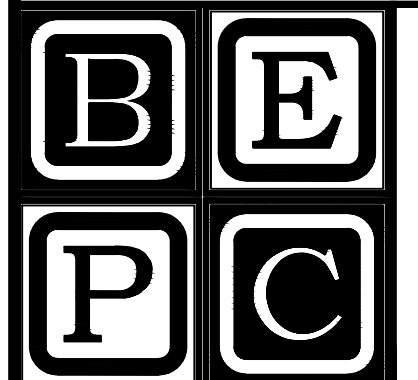

PROJECT
**REMEEDER HOUSE
 COGENERATION PROJECT**
 580 SUTTER AVE
 BROOKLYN, NY 11207

DRAWING TITLE:
GAS RISER DIAGRAM

DESIGN BY:	SP	DATE:	08/30/16
DRN BY:	SP	DATE:	08/30/16
CKD BY:	.	DATE:	.
FINAL CKD BY:	.	DATE:	.
SCALE:	AS NOTED	DATE:	
DWG No.	PAGE 7 OF 10		

P-201.00

PROJECT NO.
60-341

B-SCAN:

FEEDER SCHEDULE								
KEY	DESCRIPTION	VOLTAGE	AMPS	# SETS	CONDUCTOR SIZE	NEUTRAL SIZE	GROUND SIZE	EMT SIZE
1	COGEN TO 89L	208	150	1	#1/0	N/A	#6	3"
2	EXISTING 200A PNL TO ATS	208	100	1	#3	#3	#8	2"
3	ATS TO EXISTING 200A PNL	208	150	1	#1/0	#1/0	#6	2"
4	COGEN TO XFMR	208	150	1	#1/0	N/A	#6	2"
5	XFMR TO ATS	208	150	1	#1/0	#1/0	#6	2"

SUPPLIED, INSTALLED & TERMINATED BY ELECTRICIAN:

(XFMR) NEW 45 KVA, 208A TO 120/208Y TRANSFORMER. INSTALL GROUNDING ROD TO CHASSIS BUT DO NOT BOND TO NEUTRAL. INSTALL WITH DELTA CONNECTED TO THE GENERATOR AND WYE TOWARDS THE ATS. DO NOT BOND NEUTRAL TO GROUND.

(ATS) NEW 200A, 240VAC, 3 POLE ATS, ASCO 300 OR SIMILAR.

(ESTOP) NEW BREAK GLASS STATION FOR COGENS, 2 SETS OF PILOT CONTACTS, ONE FOR EACH COGEN.

EQUIPMENT PROVIDED BY AEGIS:
(ALL MOUNTING, WIRING, SERVICE DISCONNECTS, AND TERMINATIONS BY ELECTRICIAN EXCEPT AS NOTED)

(CG-1) COGEN - 35 KW YANMAR CP35D1 - SET BY AEGIS. ALL CONNECTIONS IN AREA OF COGEN SHOWN. SEPARATE POWER AND CONTROL CONDUITS. SEPARATE STANDBY AND NORMAL POWER CIRCUITS. ALL CONTROL WIRES CAN BE RUN IN THE SAME CONDUIT. INSTALL SUPPLEMENTARY #1/0 CHASSIS GROUND TO BUILDING STEEL OR EARTH GROUNDING ROD. INSTALL VERIS 8035 POWER METER ON INCOMING NORMAL POWER FEED (METER PROVIDED BY AEGIS)

(CCP) COGEN CONTROL PANEL

(TS-3) TANK TEMPERATURE SENSOR INSTALLED BY PLUMBERS

(BTU) BTU METER INSTALLED BY PLUMBER ON PIPING ABOVE COGENS

(P-1) PUMPS INSTALLED ON PIPING ABOVE COGENS BY PLUMBER.

(MD-1) MOTORIZED DAMPER INSTALLED BY MECHANICAL CONTRACTOR.

(F-B) FAN FOR BOILERS RELOCATED BY MECHANICAL CONTRACTOR.

NOTES: (1-2)

- MATCH POINT TO E-102.
 - CURRENT LOCATION FOR F-B. MECHANICAL CONTRACTOR TO RELOCATE TO BOILER PIT LOCATION SHOWN. ELECTRICIAN TO DISCONNECT AND REWIRE TO NEW LOCATION POWER FROM EXISTING CIRCUIT AND SAIL SWITCH. COORDINATE WITH MECHANICAL CONTRACTOR AND BUILDING
 - USE 3/4" EMT MINIMUM FOR ALL RUNS, SEPARATE CONTROL AND LINE VOLTAGE WIRE.
 - PROVIDED BY OWNER, 1) CAT5 COMMUNICATIONS LINE FOR CCP PANEL, WITH (1) DEDICATED STATIC IP.
- ELECTRICAL SUBCONTRACTOR IS RESPONSIBLE FOR FIRESTOPPING ALL PENETRATIONS. ALL FIRE STOPPING SHALL USE APPROVED SYSTEMS AND METHODS AND SHALL MEET OR EXCEED 2 HR RATING.

POWER RUNS: (11-14)
<100A

- FROM CCP TO EXISTING 200A PNL
(4) #12 W/ GND & SS (30A)
- FROM P-1 TO CCP
P-1 - (2) #12 W/GND (15A)
- (2 PLACES) FROM F-1 TO CCP
F-1 - (2) #12 W/GND & SS (15A)
- FROM F-B TO NEW LOCATION
F-B (2) # 12 W/ GND

CONTROLS: (21-28)

- FROM CG-1 TO CCP
(10) #18/2 SHIELDED, SEE WIRING NOTES ON E-002
(1) CAT5e SHIELDED
- FROM TS-3 TO CCP
(1) #18/2 SHLD
- FROM BTU TO CCP
(1) #18/2 SHLD (24V POWER)
(1) #18/3 TWISTED SHIELDED (MODBUS)
- FROM MD-1 TO CCP
(1) #18/2 SHLD (POWER)
(1) #18/2 SHLD (STATUS)
- FROM CCP TO 89L
(1) 18/3 TWISTED SHIELDED (MODBUS)
- FROM V-1 TO CCP
(1) #18/2 SHLD
- FROM F-B TO NEW LOCATION
F-B STATUS (1) # 18/2 SHLD
- FROM ESTOP TO CCP
(2) #18/2 SHLD

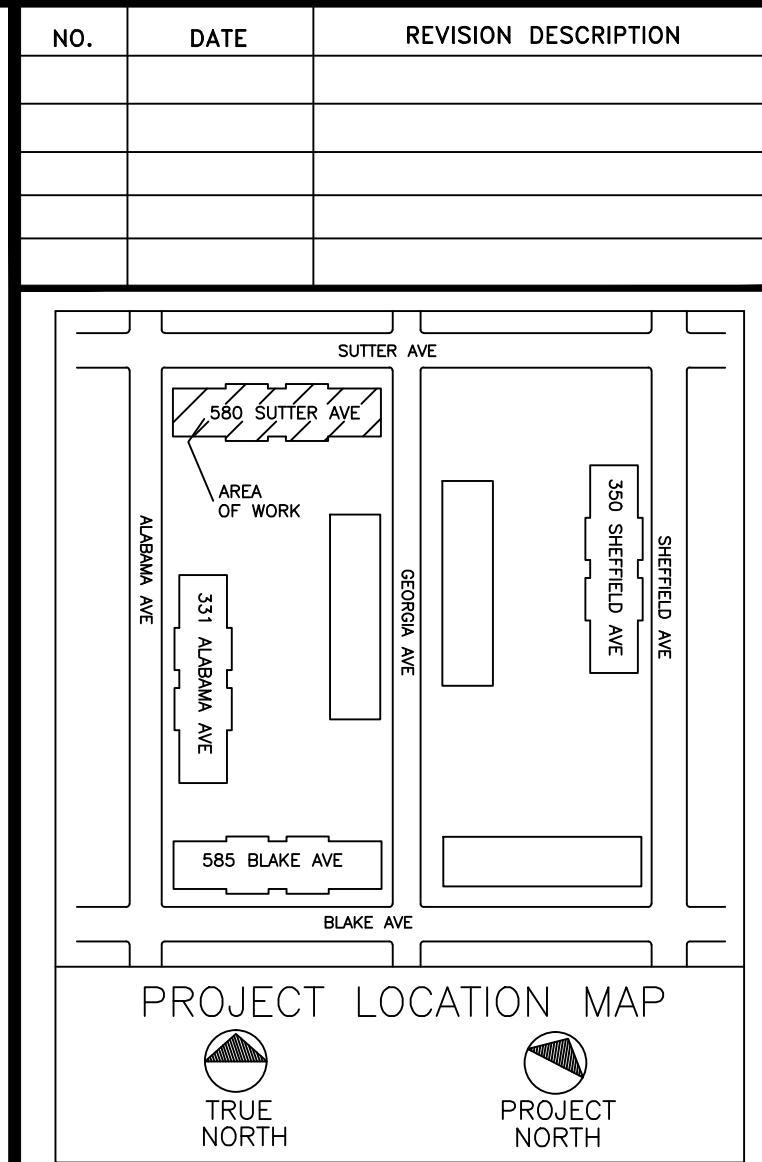

CLIENT:
AEGIS ENERGY SERVICES, INC
55 JACKSON STREET
HOLYOKE, MA 01040
TEL.: 413-536-1156
FAX: 413-536-1104
ATTN: KEVIN MAY

ALL DRAWINGS ARE TO BE READ NOT SCALED.

STATEMENT:
IT IS A VIOLATION OF THE LAW FOR ANY PERSON, UNLESS ACTING UNDER THE DIRECTION OF A LICENSED ENGINEER/ARCHITECT, TO ALTER IN ANY WAY, ANY ITEM ON THESE DRAWINGS. IF AN ITEM BEARING THE SEAL OF AN ENGINEER/ARCHITECT IS ALTERED, THE ALTERING ENGINEER/ARCHITECT SHALL AFFIX TO THIS ITEM THEIR SEAL AND THE NOTATION "ALTERED BY", FOLLOWED BY HIS/HER SIGNATURE AND THE DATE OF SUCH ALTERATION, ALONG WITH A SPECIFIC DESCRIPTION OF THE ALTERATION ON THE DRAWING.

PROPRIETARY STATEMENT:
THE PLANS AND SPECIFICATIONS HEREIN ARE INTENDED FOR THE SUBJECT PROJECT ONLY AND AS A RESULT OF CONTRACTUAL NEGOTIATIONS BETWEEN BECKER ENGINEERING, PC, THESE PLANS AND SPECIFICATIONS WILL BE THE SUBJECT OF A COPYRIGHT PETITION AND MAY NOT BE REVISED OR REUSED BY ANYONE WITHOUT THE WRITTEN AUTHORITY OF BECKER ENGINEERING, PC.

PREPARED BY:
BECKER ENGINEERING, PC
777 SUNRISE HIGHWAY, SUITE 300
LYNBROOK, NY 11563
PHONE: (516) 561-5922
FAX: (516) 823-0219 EMAIL: SUPPORT@BEPC.US
WEB: WWW.BEPC.US

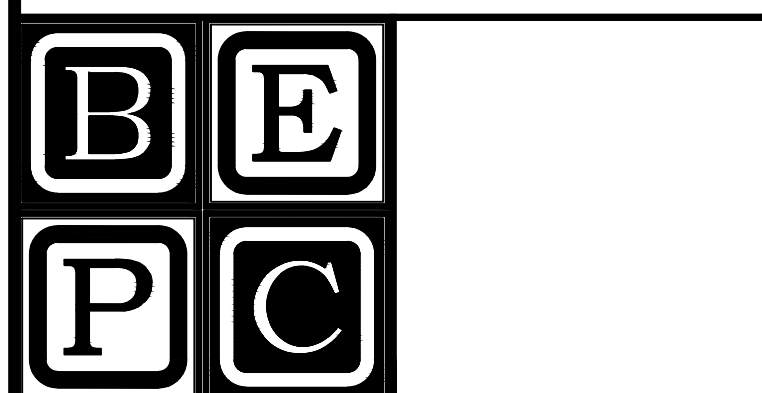

PROJECT
**REMEEDER HOUSE
COGENERATION PROJECT
580 SUTTER AVE
BROOKLYN, NY 11207**

DRAWING TITLE:
**ELECTRICAL CELLAR
PLAN**

DESIGN BY:	SP	DATE:	08/30/16
DRN BY:	SP	DATE:	08/30/16
CKD BY:	.	DATE:	.
FINAL CKD BY:	.	DATE:	.
SCALE:	AS NOTED	DATE:	
DWG No.	PAGE 8 OF 10		

E-101.00

PROJECT NO.
60-341

B-SCAN:

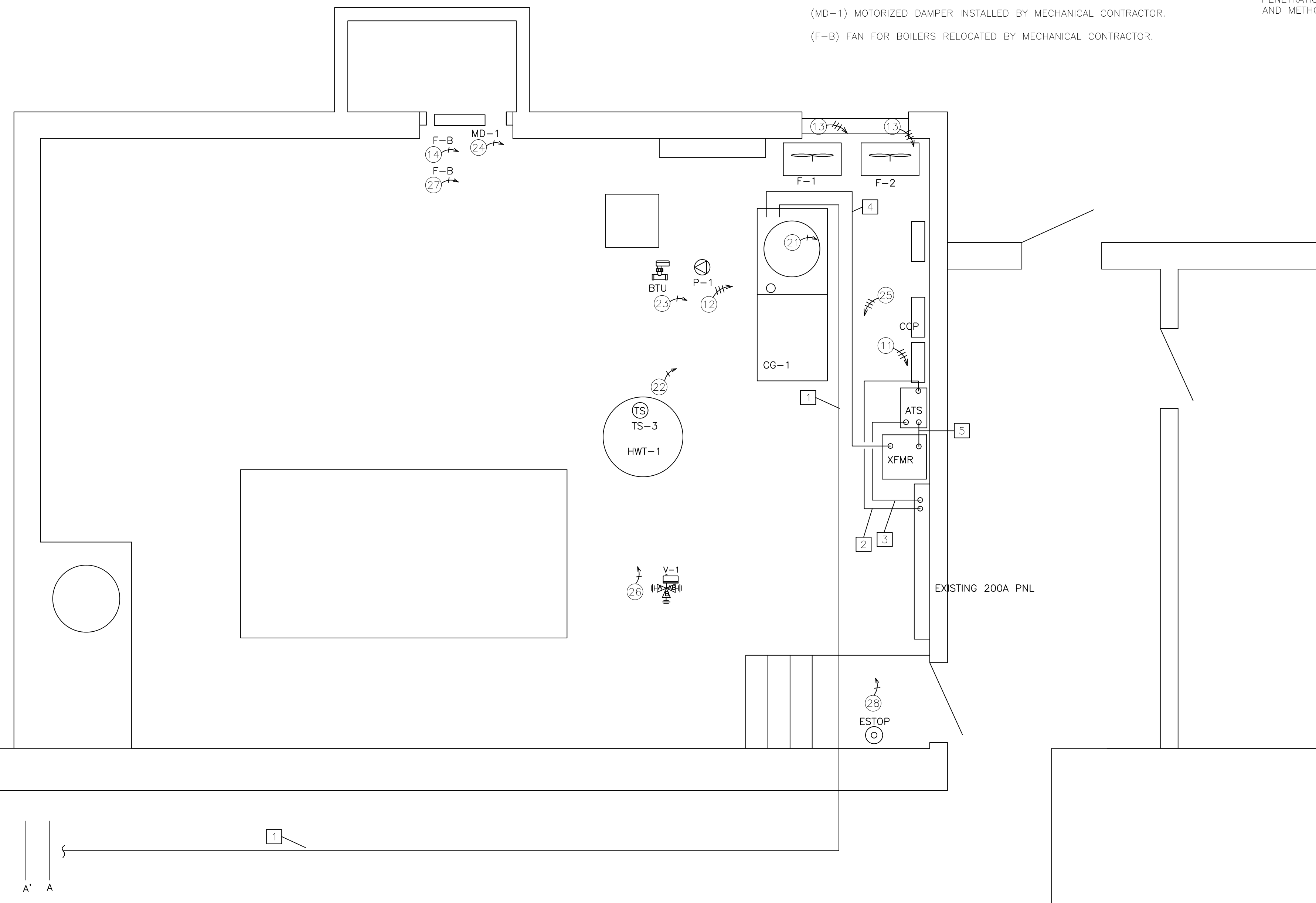

FEEDER SCHEDULE								
KEY	DESCRIPTION	VOLTAGE	AMPS	# SETS	CONDUCTOR SIZE	NEUTRAL SIZE	GROUND SIZE	EMT SIZE
1	COGEN TO 89L	208	150	1	#1/0	N/A	#6	3"
2	89L TO MAINS PANEL	208	150	1	#1/0	N/A	#1/0	2"

EQUIPMENT PROVIDED BY AEGIS:
(ALL MOUNTING, WIRING, SERVICE DISCONNECTS, AND TERMINATIONS BY ELECTRICIAN EXCEPT AS NOTED)

(MTR-MAINS) MAINS POWER METERING PANEL, INCLUDES VERIS E51 METER AND TERMINALS FOR POWER CT'S

(CT'S) INSTALL (6) CT'S ONTO MAINS ON LOAD SIDE OF CONED CT'S. DO NOT INSTALL IN CONED CT COMPARTMENT. INSTALL (3) 600A-5 FLEXCORE CT'S AND (3) FLEXIBLE "ROPE CT'S ON A/B/C CONDUCTORS.

SUPPLIED, INSTALLED & TERMINATED BY ELECTRICIAN:

(DC-VT'S) NEW 3P, 208V RATED, 30 AMP RATED, FUSED DISCONNECT WITH 15 AMP FUSES. VISIBLE BREAK, GANG OPERATED. TAP FROM ANY PANEL IN MAIN ELECTRIC ROOM

(89L) NEW 200A, 240A RATED 3 POLE FUSED DISCONNECT WITH 125A FUSES. TAP BUS ON EXISTING 1200A DISTRIBUTION PANEL. VISIBLE BREAK, GANG OPERATED, AT ARMS HEIGHT.

NOTES: (1-10)

- USE 3/4" EMT MINIMUM FOR ALL RUNS, SEPARATE CONTROL AND LINE VOLTAGE WIRE.
- PROVIDED BY OWNER, 1) CAT5 COMMUNICATIONS LINE FOR CCP PANEL, WITH (1) DEDICATED STATIC IP.
- ELECTRICAL SUBCONTRACTOR IS RESPONSIBLE FOR FIRESTOPPING ALL PENETRATIONS. ALL FIRE STOPPING SHALL USE APPROVED SYSTEMS AND METHODS AND SHALL MEET OR EXCEED 2 HR RATING.

POWER RUNS: (11-12)
<100A

- ⑪ FROM DC-VT'S TO MTR-MAINS
(4) #12 & GND (15A)
- ⑫ FROM CT'S TO MTR-MAINS
(6) #12 W/GND (FLEXCORE CT'S)
(3) #18/2 SHLD (ROPE CT'S)

CONTROLS: (21 ONLY)
CONTROLS:

- ② FROM MTR-MAINS TO CG-1
(1) #18/2 SHLD

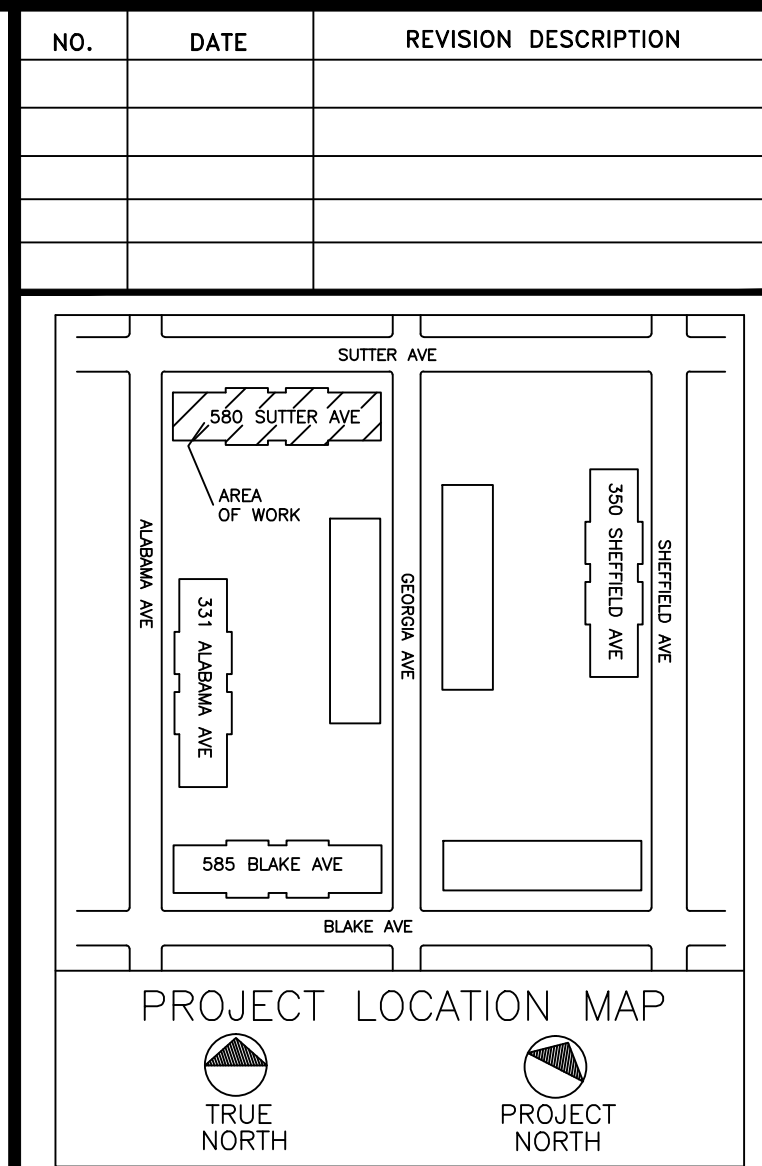

CLIENT:
AEGIS ENERGY SERVICES, INC
55 JACKSON STREET
HOLYOKE, MA 01040
TEL.: 413-536-1156
FAX: 413-536-1104
ATTN: KEVIN MAY

ALL DRAWINGS ARE TO BE READ NOT SCALED.

STATEMENT:
IT IS A VIOLATION OF THE LAW FOR ANY PERSON, UNLESS ACTING UNDER THE DIRECTION OF A LICENSED ENGINEER/ARCHITECT, TO ALTER IN ANY WAY, ANY ITEM ON THESE DRAWINGS. IF AN ITEM BEARING THE SEAL OF AN ENGINEER/ARCHITECT IS ALTERED, THE ALTERING ENGINEER/ARCHITECT SHALL AFFIX TO THIS ITEM THEIR SEAL AND THE NOTATION "ALTERED BY", FOLLOWED BY HIS/HER SIGNATURE AND THE DATE OF SUCH ALTERATION, ALONG WITH A SPECIFIC DESCRIPTION OF THE ALTERATION ON THE DRAWING.

PROPRIETARY STATEMENT:
THE PLANS AND SPECIFICATIONS HEREIN ARE INTENDED FOR THE SUBJECT PROJECT ONLY AND AS A RESULT OF CONTRACTUAL NEGOTIATIONS BETWEEN BECKER ENGINEERING, PC, THESE PLANS AND SPECIFICATIONS WILL BE THE SUBJECT OF A COPYRIGHT PETITION AND MAY NOT BE REVISED OR REUSED BY ANYONE WITHOUT THE WRITTEN AUTHORITY OF BECKER ENGINEERING, PC.

PREPARED BY:
BECKER ENGINEERING, PC
777 SUNRISE HIGHWAY, SUITE 300
LYNBROOK, NY 11563
PHONE: (516) 561-5922
FAX: (516) 823-0219 EMAIL: SUPPORT@BEPC.US
WEB: WWW.BEPC.US

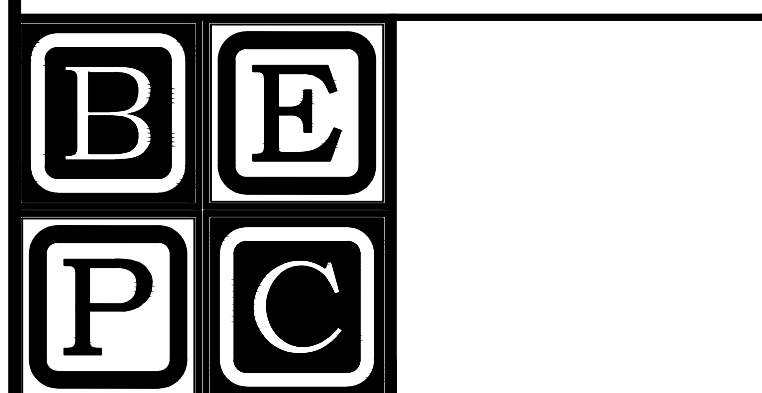

PROJECT
**REMEEDER HOUSE
COGENERATION PROJECT
580 SUTTER AVE
BROOKLYN, NY 11207**

DRAWING TITLE:
**ELECTRICAL CELLAR
PLAN**

DESIGN BY:	SP	DATE:	08/30/16
DRN BY:	SP	DATE:	08/30/16
CKD BY:	.	DATE:	.
FINAL CKD BY:	.	DATE:	.
SCALE:	AS NOTED	DATE:	.
DWG No.	PAGE 9 OF 10		

E-102.00
PROJECT NO.
60-341

B-SCAN:

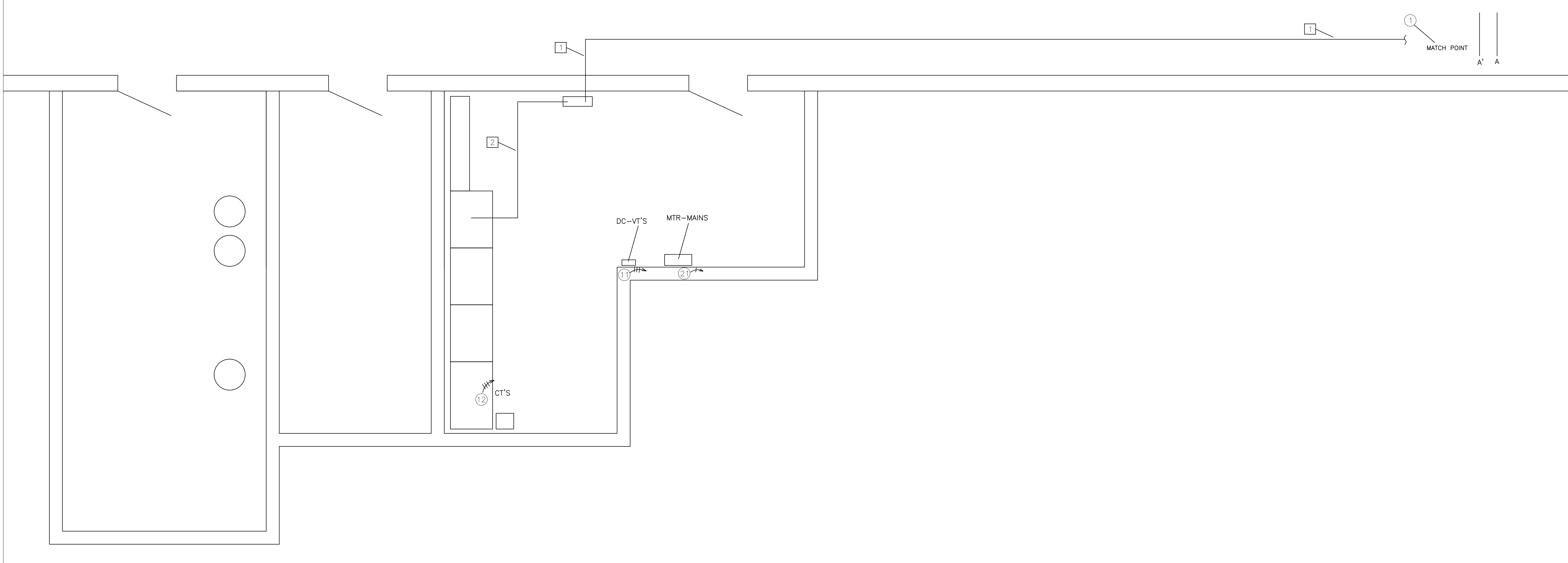

NOTES:

1. ALL CONDUITS AND EQUIPMENTS SHALL BE GROUNDED AS PER NYC ELECTRICAL CODE ART. 250.
2. ALL WORK SHALL BE IN CONFORMANCE WITH NYC ELECTRICAL CODE ART. 705 PART I & III, AND ART 445.

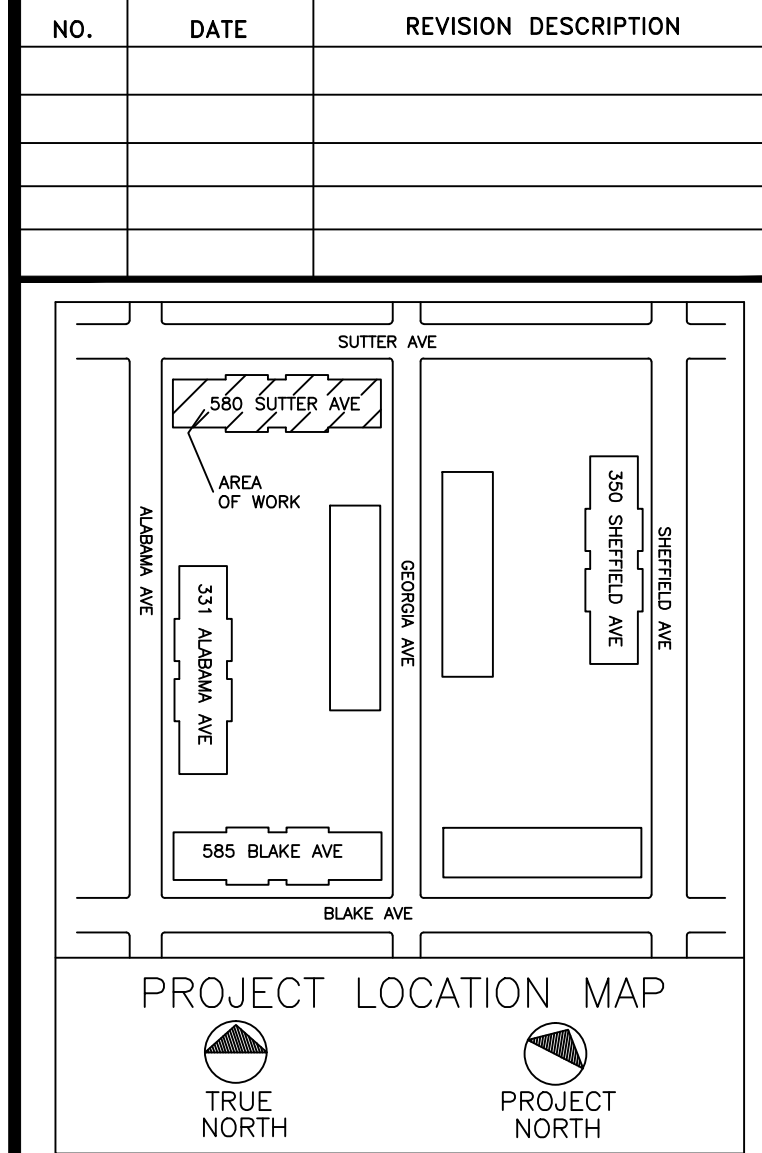
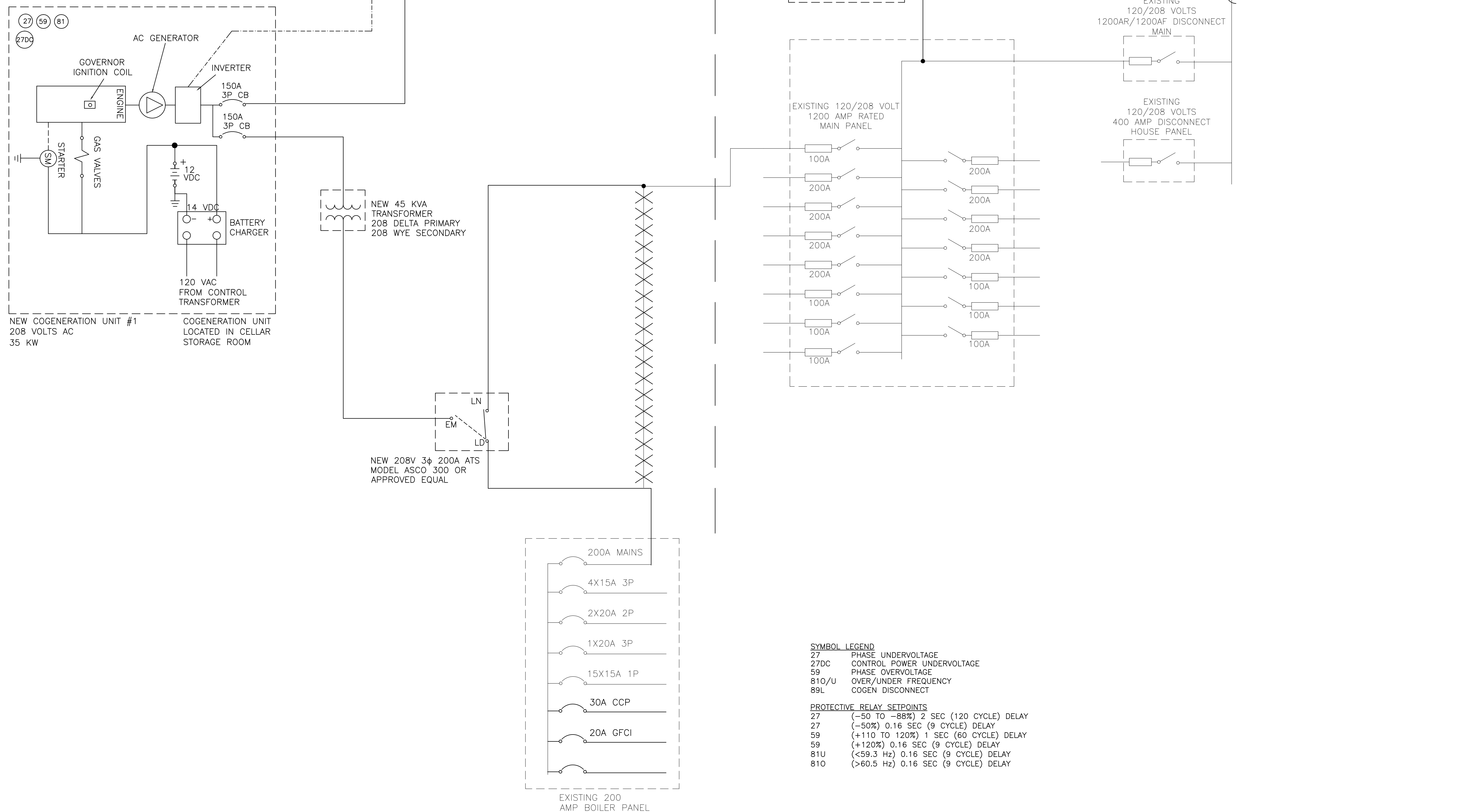

CLIENT:
AEGIS ENERGY SERVICES, INC
 55 JACKSON STREET
 HOLYOKE, MA 01040
 TEL.: 413-536-1156
 FAX: 413-536-1104
 ATTN: KEVIN MAY

ALL DRAWINGS ARE TO BE READ NOT SCALED.

STATEMENT:
 IT IS A VIOLATION OF THE LAW FOR ANY PERSON, UNLESS ACTING UNDER THE DIRECTION OF A LICENSED ENGINEER/ARCHITECT, TO ALTER IN ANY WAY, ANY ITEM ON THESE DRAWINGS. IF AN ITEM BEARING THE SEAL OF AN ENGINEER/ARCHITECT IS ALTERED, THE ALTERING ENGINEER/ARCHITECT SHALL AFFIX TO THIS ITEM THEIR SEAL AND THE NOTATION "ALTERED BY", FOLLOWED BY HIS/HER SIGNATURE AND THE DATE OF SUCH ALTERATION, ALONG WITH A SPECIFIC DESCRIPTION OF THE ALTERATION ON THE DRAWING.

PROPRIETARY STATEMENT:
 THE PLANS AND SPECIFICATIONS HEREIN ARE INTENDED FOR THE SUBJECT PROJECT ONLY AND AS A RESULT OF CONTRACTUAL NEGOTIATIONS BETWEEN BECKER ENGINEERING, PC. THESE PLANS AND SPECIFICATIONS WILL BE THE SUBJECT OF A COPYRIGHT PETITION AND MAY NOT BE REVISED OR REUSED BY ANYONE WITHOUT THE WRITTEN AUTHORITY OF BECKER ENGINEERING, PC.

PREPARED BY:
BECKER ENGINEERING, PC
 777 SUNRISE HIGHWAY, SUITE 300
 LYNBROOK, NY 11563
 PHONE: (516) 561-5922
 FAX: (516) 823-0219 EMAIL: SUPPORT@BEPC.US
 WEB: WWW.BEPC.US

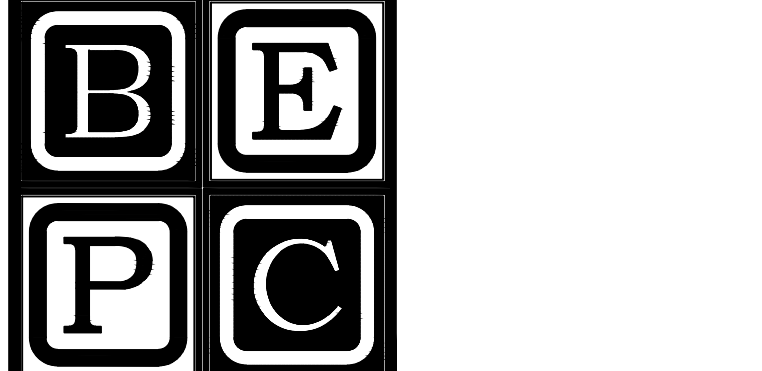

PROJECT
**REMEEDER HOUSE
 COGENERATION PROJECT**
 580 SUTTER AVE
 BROOKLYN, NY 11207

DRAWING TITLE:
**ELECTRICAL ONE LINE
 DIAGRAM**

DESIGN BY:	SP	DATE:	08/30/16
DRN BY:	SP	DATE:	08/30/16
CKD BY:	.	DATE:	.
FINAL CKD BY:	.	DATE:	.
SCALE:	AS NOTED	DATE:	
DWG No.		PAGE	10 OF 10

E-201.00

PROJECT NO.
60-341

B-SCAN: